

Terminator Salvation™



Setup and Operations Manual

32" Dedicated Game

Table of Contents

Safety	3
Product Specifications.....	5
Setup	6
Adjustments, Audits and Diagnostics	9
Maintenance	27
Wiring.....	35
Gun Parts and Wiring.....	40
Troubleshooting.....	45
CoinUp® Operation Overview.....	52
Forms	61

Terminator Salvation™ 32" Dedicated Game

Safety

OPERATION

Before operating game, read this manual. Failure to properly install and operate this game could result in malfunction or accident. Operate the game in accordance with the manual.

TRANSPORTING

The cabinet is very heavy. Because the monitor is high, the cabinet is also very top-heavy. Use appropriate care when moving or transporting cabinet. It contains fragile glass and electronic components. Avoid rough handling.

HANDLING COMPONENTS

Many components are extremely sensitive to handling, environmental and Electrostatic Discharge (ESD) events—especially the computer. Do not handle it roughly. Before servicing, call your distributor and inquire about the PC warranty. Use proper ESD procedures when servicing. Protect components from harmful environmental conditions, such as extreme temperatures, excessive moisture or other damaging effects.

DISCONNECT POWER

Always turn the power off and unplug the unit before servicing or making adjustments unless otherwise instructed. Installing or repairing components while power is on can damage the components and void the warranty.

GROUNDING

Avoid electrical shock. Do not plug in AC power until you have inspected and properly grounded the unit. Only plug into a grounded, three-wire outlet. Do not use a “cheater” plug or cut off the ground pin on the line cord.

ELECTRICAL SHOCKS

There is no isolation transformer in the cabinet. Disconnect AC power before servicing. However, be aware that lethal voltages can remain in the electronic components even when AC power is disconnected. Use extreme caution when servicing. Verify that there is a working ground connection. If the unit sustains water damage, cease using it immediately and unplug AC power.

MONITOR

The monitor contains no user serviceable parts. Do not attempt to service the monitor.

POWER SELECTOR

Before installing game, ensure the voltage on the PC is set properly. There is a 115/230 VAC selector switch that must be set for the correct voltage for your site. Verify the fluorescent lamp rating. The rating must match the line voltage at the installation site.

POWER CORD

If the power cord is damaged or lost, replace it with an identical cord as supplied by the manufacturer or an authorized service agent.

SURGE SUPPRESSOR

It is recommended that you plug your game's power cord into a surge suppressor to help protect from power surges that may damage sensitive electronic components.

CONNECTORS

When servicing machine, ensure all connectors mate properly. If connectors do not slip in easily, do not force them. Connectors are often keyed and only connect one way. Check for correct orientation.

COMPUTER

The computer contains sensitive components, including a hard drive. Do not handle it roughly. Call your distributor before servicing its internal components. Ask about warranty information as it relates to the PC.

Do not turn the PC power switch on or off. It should remain permanently in the ON position.

Cycle AC power on or off with the cabinet power switch.

A dongle has been inserted into one of the USB ports. This is required for game play.

Do not remove the dongle except for troubleshooting purposes.

FLUORESCENT TUBES

A dropped fluorescent tube may break and implode. Shattered glass from the implosion can travel long distances and cause bodily injury. Use proper procedures when handling broken materials, as these items can contain hazardous material such as mercury or lead.

HAZARD TO EPILEPTICS

A small portion of the population has an epileptic condition that may cause seizures. Affected persons experience seizure while watching some television pictures or playing certain video games. People who have not had seizures may still have an undetected epileptic condition. If anyone in your family has experienced epilepsy symptoms (seizures or loss of awareness), consult your physical before using video games. While children play video games, a parent should observe. Be alert to the following symptoms: dizziness, altered vision, eye or muscle twitching, involuntary movements, loss of awareness, disorientation or convulsions. If you or your child experiences these symptoms, discontinue use immediately and consult your physician.

MANUAL

Keep this manual available and ready for use. If the game fails to function properly, turn off the machine and unplug the AC line cord. Contact your local distributor. Your warranty, when applicable, lasts 60 days from your purchase date. You may not reproduce this document or any of its contents without written authorization from Raw Thrills, Inc. or Play Mechanix™ Inc.

SPECIFICATIONS

For reasons such as performance, this product's specifications may change without notice. Federal patent, copyright and other intellectual property laws protect the content, devices and design of the game and its equipment.

Terminator Salvation™ 32" Dedicated Game

Product Specifications

Electrical Power

United States, international and Japan

Inrush AC Current: 7 Amps

Operating AC Current: 5 Amps

Voltage: 115 VAC

Temperature

50° F to 104° F

(10° C to 40° C)

Humidity

Must not exceed 95% relative humidity

Dimensions

Height: 81" (2.06 meters)

Width: 39" (.99 meters)

Depth: 55" (1.39 meters)

Carton Weight

405 lbs. (184 kg)

Setup

Unpack Materials

1. Place the shipping crates on a flat, stable surface.
2. Cut the banding straps and remove the cardboard lids.
3. Lift off the large cardboard containers surrounding the front pedestal and monitor assemblies and remove any shipping cleats.
4. Remove the coin door key from the coin return slot.
5. Open the top coin door.
6. Locate the keys for the back door and the cash box door.
7. Open the cash box door and remove the cash box.
8. Check for shipping damage to the following:
 - Left and right guns, cables and decals
 - Marquee and monitor
 - Cabinet decals
9. Check the AC line cord for visible signs of damage.

Pay particular attention to the plug and line cord insulation.

Check Electrical Settings

1. Verify the voltage in the nearest AC outlet.
2. Verify the AC outlet ground connection is present and working.
3. Open the back door of the monitor assembly.
4. Near the AC power transformer, verify the voltage selector switch is set to correct AC voltage.
5. Route the line cord so that the plug is near the AC outlet.
6. Replace the back door of the monitor assembly.

Startup Game

1. Plug in line cord to AC outlet.
2. Turn the power switch to ON.
3. Check that no component is excessively hot or emitting foul odors.
If not, turn off AC power and disconnect line cord. Refer to the diagnostic section of this manual.
4. Once software loads, you will be asked to calibrate the guns.
If not, enter the service menu by pressing the TEST button located on the bracket inside the top coin door.

Terminator Salvation™ 32" Dedicated Game

Diagnostics and Adjustments

The Service Button Panel has four buttons, three of which can navigate the menu system. But it is easiest to navigate with a Start button and trigger/grenade.

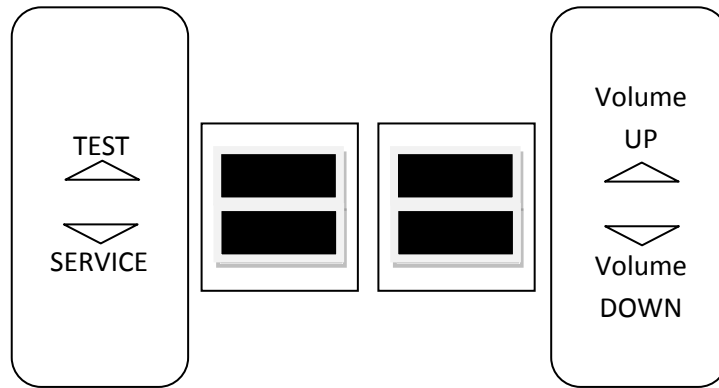

- Service Panel TEST/BACK button enters diagnostic system.
- Either Start button or SELECT button selects the highlighted option.
- Service Panel VOL DOWN button or Squeezing either trigger moves down through menu or setting choices.
- Service Panel VOL UP button or pressing either grenade button moves up through menu or setting choices.
- Highlight and select Exit to return to previous screen.

An on-screen message acknowledges changes or when you exit a selection without making a change.

At the bottom of each screen there is a brief description of the menu option's function. A complete description is available here for all menu functions.

Instructions for completing your first calibration start on the next page.

1. If the calibration screen is not visible, press the TEST button to enter the Diagnostic System.
2. From the Main Menu, use a gun trigger to highlight Gun Calibration.
3. Press a Start button to enter calibration.

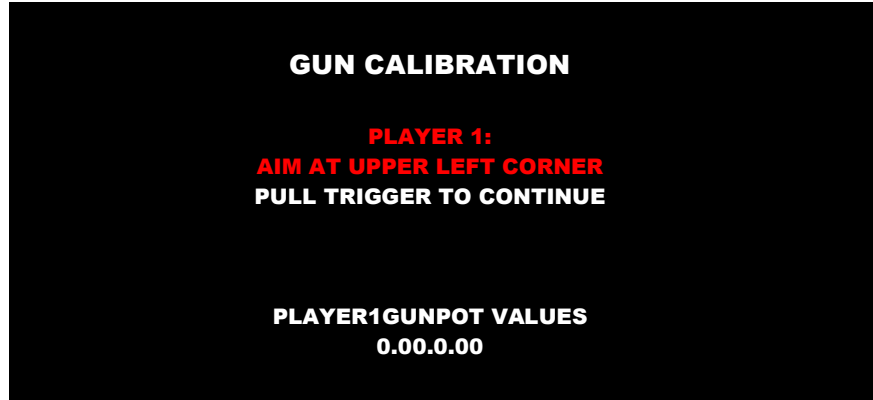

4. Follow on-screen instructions and repeat for right gun.
5. Pull trigger to exit calibration.
6. From Main Menu, squeeze a gun trigger to cycle through choices until you reach System Tests.
7. Press a Start button to select System Tests Menu.

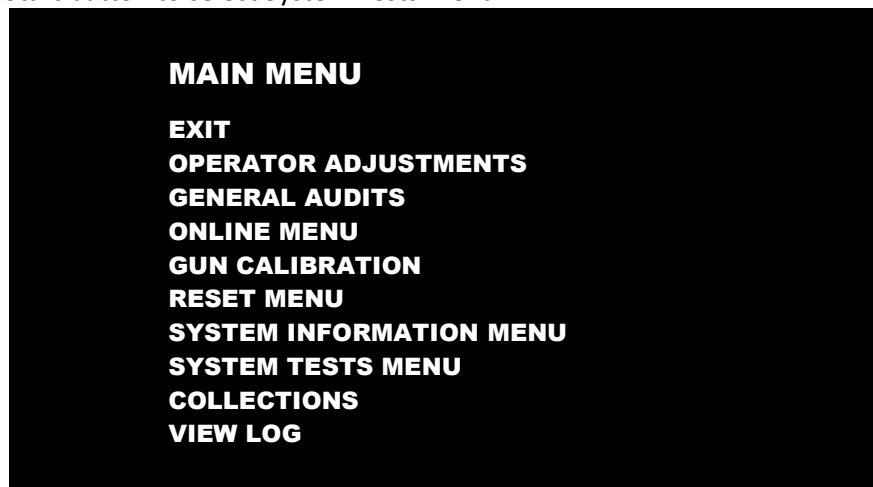

Other Tests

See the Diagnostic Section for further information.

1. Enter the Switch Test menu and verify all switches function.
2. Enter the Screen Test menu and verify that video is acceptable.
3. Enter the Sound Test menu and verify the audio works and is not distorted.
4. Enter the Coin Meter Test menu and verify the operation of the coin meter.
5. Enter the Cabinet Lamps Test menu and verify that all cabinet lights work correctly.
6. Enter the Watchdog Test menu, which reboots the game.
7. Upon a successful reboot, you are ready to make adjustments to pricing, volume and other functions found in the Adjustments, Audits and Diagnostics section.

Terminator Salvation™ 32" Dedicated Game

Adjustments, Audits and Diagnostics

Main Menu

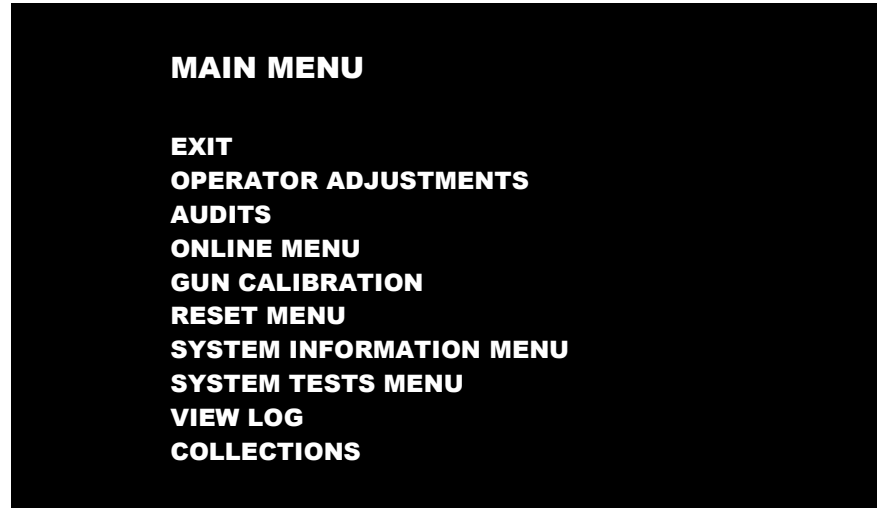

Main Menu

Operator Adjustments Menu

This menu controls gameplay, coinage and sound adjustments.



You can improve collections by customizing performance with game adjustments. Each variable on an adjustment menu changes an aspect of game play or appearance. Optimizing these settings can maintain player interest and improve earnings. Monitor the effects of adjustments by comparing audit information and earnings before and after changes.



This controls elements of the player experience and the time the game contacts the CoinUp® server to check for software updates.

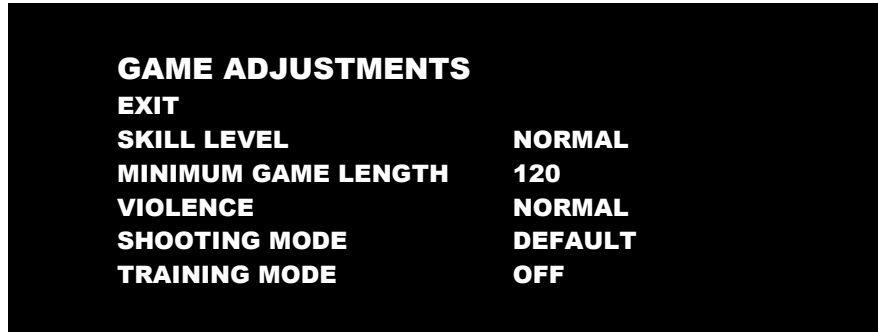

Settings, Defaults and Choices

Setting	Description	Default	Choices
Skill Level	Adjusts game difficulty by changing how gun reloads. <ul style="list-style-type: none"> EASY. Ammunition is restored whenever clip runs out. NORMAL. After each 60 shots, player must reload by pumping gun magazine clip. 	Normal	Normal / Easy
Minimum Game Length	Adjusts length of game in seconds and adjusts damage amounts. The time can be changed in five-second increments.	120	20 - 300
Violence	Toggles the display of certain violent scenes in the game.	Normal	Normal / Low
Shooting Mode	Enables gun sight and tracer bullets for all guns	Default	Default / Gun Sight & Tracer
Training Mode	Shows extra training videos at start of game	Off	Off/On

Terminator Salvation™ 32" Dedicated Game

Main Menu

Operator Adjustments Menu

Coin Settings Menu

This menu does **not** set game price, but specifies how much game credit is given for money added to the machine. The smallest accepted coin is a quarter, the typical setting for both coin values in the U.S. The DBV value is also a multiple of 25¢.

COIN SETTINGS	
EXIT	
FREEPLAY	OFF
CURRENCY TYPE	Dollar
COIN 1 VALUE	\$0.25
COIN 2 VALUE	\$0.25
COIN 3 VALUE/DBV PULSE	\$0.25
MAXIMUM CREDITS	\$500.00
BONUS AWARD	\$0.00
UNITS FOR BONUS	\$0.00

Settings, Defaults and Choices

Setting	Description	Default	Choices
Freeplay	Players can start games without money by pressing START. Use this for promotions, non-commercial applications or to test the machine.	Off	On / Off
Currency Type	Changing currency type resets coin door values. The denomination symbol changes on screen with each currency.	US Dollar	Yen, Won, Ruble, Real, Peso, Krona, Guilder, Franc, Can. Dollar, Coins, Euro, NZ Dollar, Rand, Pound, Aus. Dollar
Coin 1 Value	Lets you set coin slot pricing.	\$0.25	\$0.25 - \$63.75 in \$.25 increments
Coin 2 Value	Lets you set coin slot pricing.	\$0.25	\$0.25 - \$63.75 in \$.25 increments
Coin 3 Value / DBV Pulse	The bill validator (DBV) translates bills into electronic pulses. Every \$1 bill results in four pulses; each \$5 bill is 20 pulses; \$10 bill is 40 pulses, etc. This setting determines how much game credit is awarded per pulse. With default setting of \$0.25, every \$1 bill will award \$1 in game credit. Set to \$0.50, every \$1 bill will award \$2 in game credit.	\$0.25	\$0.25 - \$63.75 in \$.25 increments
Maximum Credits	The highest number of unplayed credits allowed.	\$500	\$125 - \$500 in \$.25 increments
Bonus Award	The amount of credit awarded per bonus unit (see below).	\$0.00	\$0.00 - \$63.75 in \$.25 increments
Units for Bonus	The value a player must enter to get bonus credit.	\$0.00	\$0.00 - \$50.00 in \$.25 increments

Bonus Award/Units for Bonus example.

To give players \$1.25 in credit for every dollar put in the DBV, set Bonus award to \$.25 and Units for Bonus to \$1.

Main Menu
Operator Adjustments Menu
Player Cost Menu

PLAYER COST			
TYPE	-----OPER FEE	----COINUP FEE	--- TOTAL
EXIT			
START COST	\$1.00	\$0.00	\$1.00
CONTINUE COST	\$1.00	\$0.00	\$1.00

Settings, Defaults and Choices

Setting	Description	Default	Choices
Start Cost	The amount of money required to begin a game.	\$1.00	\$0.00 - \$63.75 in \$0.25 increments
Continue Cost	The amount of money required for a player to continue a game.	\$1.00	\$0.00 - \$63.75 in \$0.25 increments

FEE ADJUSTMENT

Note that CoinUp® fee cannot be adjusted by the operator.

Terminator Salvation™ 32” Dedicated Game

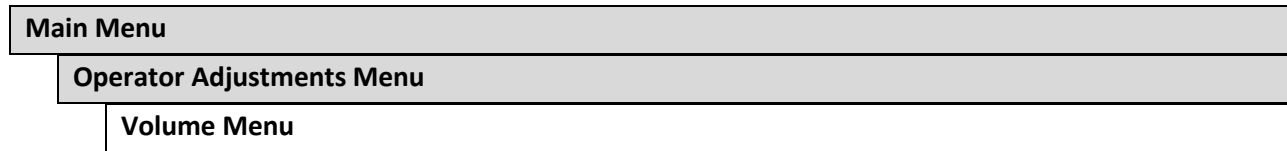

Rather than requiring a manual dial or up/down buttons, all volume adjustments can be made digitally with this menu. However, during Attract Mode, pressing the Service Panel Vol + and Vol – buttons only adjusts Attract Mode volume.

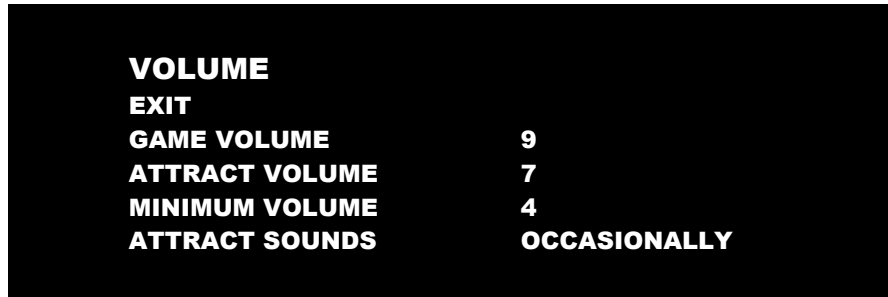

Settings, Defaults and Choices

Setting	Description	Default	Choices
Game Volume	This affects sound only while game is played.	9	0 – 32
Attract Volume	This can be silenced or turned up as an advertisement to draw in players.	7	0 – 32
Minimum Volume	Determines the lowest setting possible for both Game and Attract Volumes	4	0 – 32
Attract Sounds	This determines how often the game’s “advertising” sounds will be heard.	Occasionally	Never/Occasionally/Always

Main Menu
Audits Menu

Audit screens help assess game performance, find intermittent problems, decide whether to adjust game difficulty and free game award and help maximize game earnings.



Main Menu
Audits Menu
General Audits

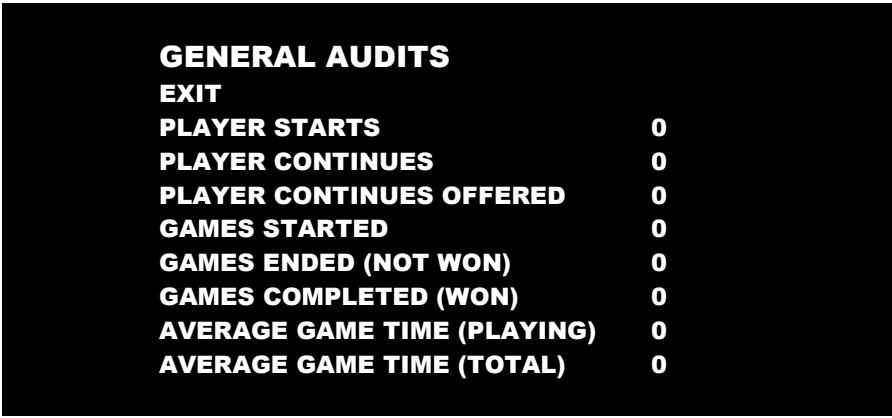

Terminator Salvation™ 32" Dedicated Game

Main Menu

Audits Menu

System Audits

SYSTEM AUDITS	
EXIT	
PLAY TIME	0 yr 0 dy—0:00:00
UP TIME	0 yr 0 dy—0:00:00
WATCHDOGS	0
EXCEPTIONS	0
BAD TRAPS	0

Main Menu

Audits Menu

Coin Audits Menu

COIN AUDITS	
EXIT	
TOTAL COIN 1	\$0.00
TOTAL COIN 2	\$0.00
TOTAL COIN 3 (DBV)	\$0.00
BONUS COINS	\$0.00
LIFETIME COIN COUNT	\$0.00
SERVICE CREDITS	\$0.00

Main Menu

Online Menu

These menus are used by games connected to CoinUp®. See CoinUp® Operation Overview section in this manual and visit www.coinup.com for more information.

Main Menu**Gun Calibration Menu**

This is the same procedure described earlier in the **First Calibration** section.

Main Menu**Reset Menu**A black rectangular box containing white text. The text is centered and lists the following options: RESET MENU, EXIT, RESET GAME AUDITS, RESET HIGH SCORES, RESET CREDITS, RESET COIN COUNTERS, RESET ADJUSTMENTS, and FACTORY RESET.

RESET MENU
EXIT
RESET GAME AUDITS
RESET HIGH SCORES
RESET CREDITS
RESET COIN COUNTERS
RESET ADJUSTMENTS
FACTORY RESET

Reset Game Audits zeroes out game audits, system audits and game purchase audits.

Reset High Scores zeroes out high score tables.

Reset Credits zeroes out money in.

Reset Coin Counters zeroes out coin audits, but leaves alone lifetime and service credits.

Reset Adjustments sets operator adjustments to defaults.

Factory Reset performs all the above resets.

Main Menu**System Information Menu**

These submenus can give you information on how the system has been functioning and on various settings and updates.

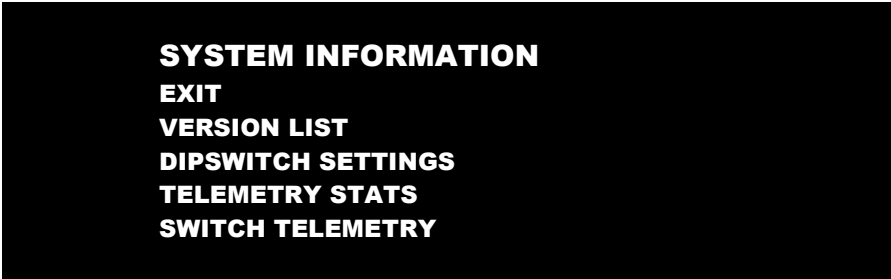
A black rectangular box containing white text. The text is centered and lists the following options: SYSTEM INFORMATION, EXIT, VERSION LIST, DIPSWITCH SETTINGS, TELEMETRY STATS, and SWITCH TELEMETRY.

SYSTEM INFORMATION
EXIT
VERSION LIST
DIPSWITCH SETTINGS
TELEMETRY STATS
SWITCH TELEMETRY

Terminator Salvation™ 32" Dedicated Game

Main Menu

System Information

Version List

For troubleshooting purposes, this menu gives you information on the latest update of various components.

VERSIONS

EXIT

SOUND 19.3

JAMMA 25q.H8b.Fd1.U2a R

COINUP 1.08.00

SOFTWARE 00.84.00.US.D – Build: Jul 26 2010

11:39:04

LINUX KERNEL 2.6.24.2-ji3

PROCESSOR AMD Athlon II 240 Processor

BIOS VENDOR: Dell VERS: A01 DATE: 2/4/10

MEMORY 2072780 kB

SERIAL NUMBER 223

RIO HW:8010 SW:6

Main Menu

System Information

DIP Switch Settings

This checks the DIP Switch settings on the RIO Board

DIPSWITCH SETTINGS

DIPSWITCH 1 ON

DIPSWITCH 2 OFF

DIPSWITCH 3 OFF

DIPSWITCH 4 OFF

DIPSWITCH 5 OFF

DIPSWITCH 6 OFF

DIPSWITCH 7 OFF

DIPSWITCH 8 OFF

RESOLUTION

RESOLUTION

GUN SCAN EtelemeGA

HSYNC/VSYNC POLARITY

UNUSED

UNUSED

UNUSED

UNUSED

PRESS START TO EXIT

Main Menu**System Information****Telemetry Stats**

These tests check thermal qualities and electrical conductivity. Generally, only Core Temps 1 and 2 function. The rest should read N/A.

TELEMETRY DATA

EXIT	
SYSTEM TEMPERATURE	N/A
CORE TEMP1	23C
CORE TEMP2	26c
TEMPERATURE STATE	N/A
CPU FAN SPEED	N/A
CASE FAN SPEED	N/A
+3.3V:	N/A
+5.0V:	N/A
+12.0V:	N/A
-5.0V:	N/A
-12.0v	N/A

Terminator Salvation™ 32" Dedicated Game

Main Menu

System Information

Switch Telemetry Data

This gives information on the time since a switch was last used in both number of games played since the switch was used and the clock time since last use.

SWITCH TELEMTRY DATA		
EXIT		
SWITCH	GAMES NOT SEEN	TIME LAST SEEN
LEFT START	0	0d00.02.22
RIGHT START	0	0d00.02.22
LEFT TRIGGER	0	0d00.02.22
LEFT PUMP	0	0d00.02.22
LEFT GRENADE	0	0d00.02.22
RIGHT TRIGGER	0	0d00.02.22
RIGHT PUMP	0	0d00.02.22
RIGHT GRENADE	0	0d00.02.22
COIN 1	0	0d00.02.22
COIN 2	0	0d00.02.22
DIAG	0	0d00.02.22
VOLUME UP	0	0d00.02.22
VOLUME DOWN	0	0d00.02.22
DBV	0	0d00.02.22
SERVICE CREDIT	0	0d00.02.22

Main Menu

System Tests Menu

These tests check the functioning of peripherals.

SYSTEM TESTS
EXIT
GUN TESTS MENU
ONLINE TESTS MENU
SWITCH TEST
SCREEN TESTS
SOUND TEST
FILE TEST
COIN METER TEST
CABINET LAMPS TEST
WATCHDOG TEST

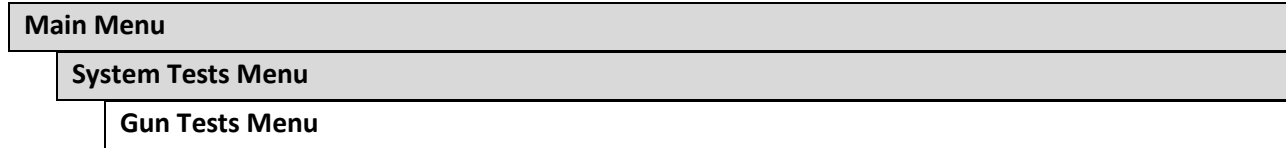

Some gun test descriptions can be found in the First Calibration section earlier in this manual.



Gun Click Test is shown below.

Gun Calibration is described elsewhere in this manual.

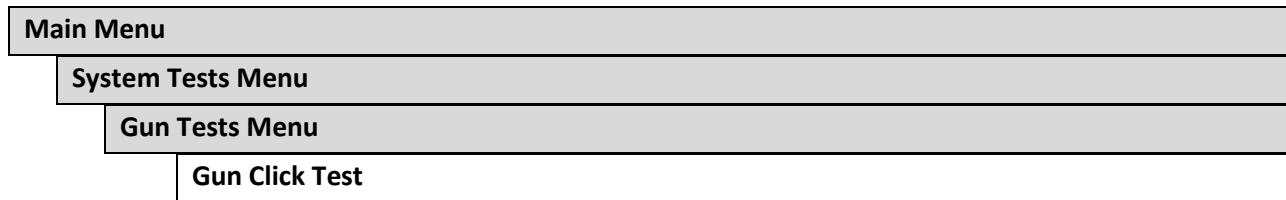

This tests the various click mechanics of the gun.

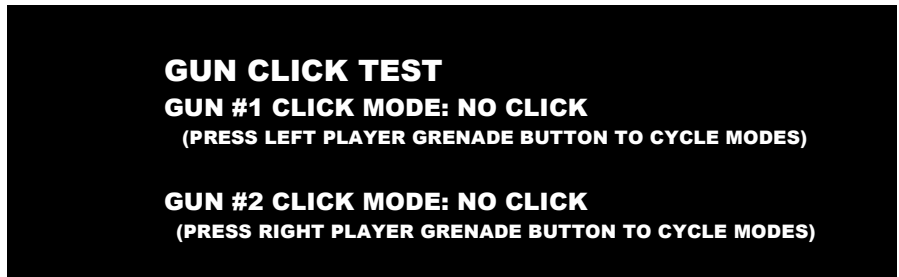

Point the gun at the screen for this test.

Pressing the grenade button cycles through “NO CLICK,” “SINGLE CLICK ON TRIGGER PULL” and AUTO CLICK ON TRIGGER PULL.”

Terminator Salvation™ 32" Dedicated Game

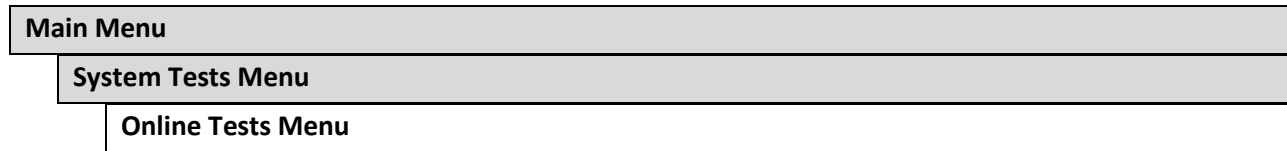

These tests verify components of the online system.

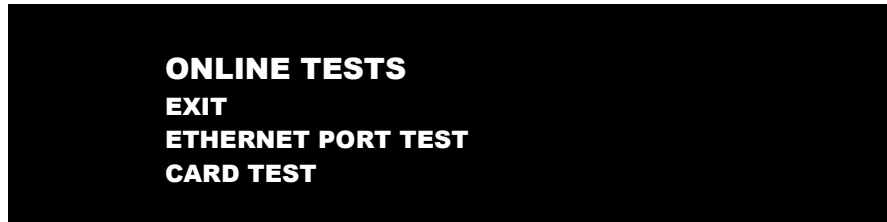

This verifies the functioning of the Ethernet port.

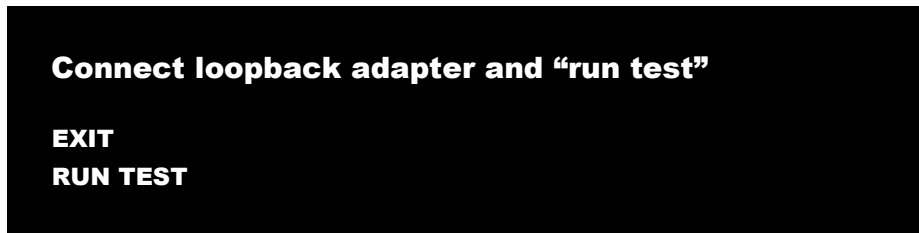

If there is a card reader, insert a valid card to reveals the card type (player or operator) and the cardholder's name.

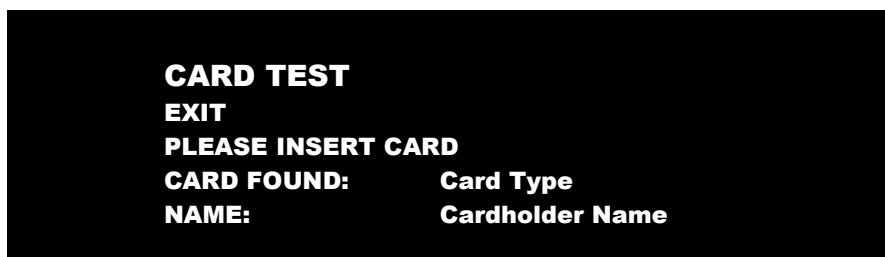

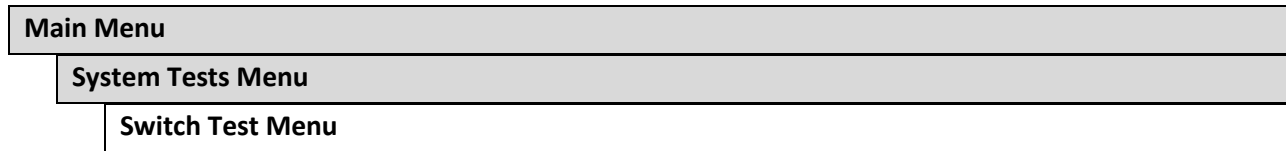

This checks input switch performance. The activated switch is highlighted on screen.

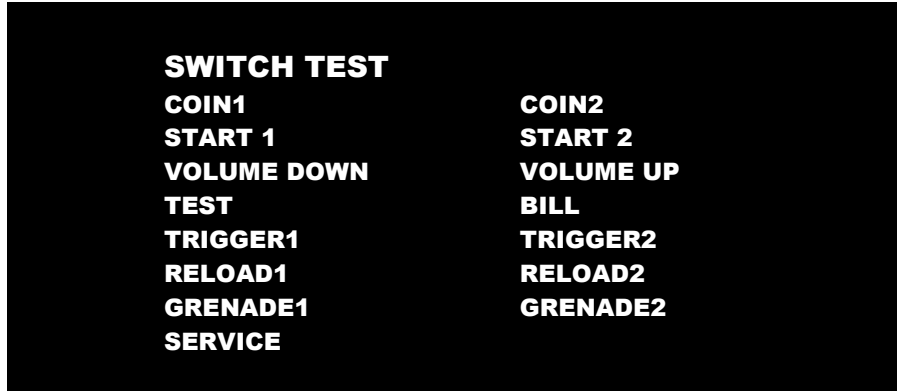

The Switch Test menu has a unique exit procedure because it checks the switches normally used for navigation. To exit to the main menu, simultaneously press a Start button and squeeze a trigger.

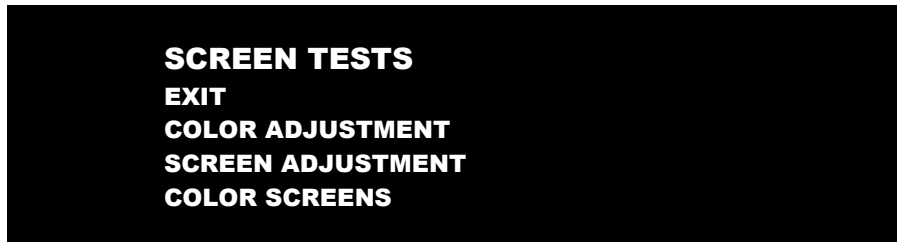
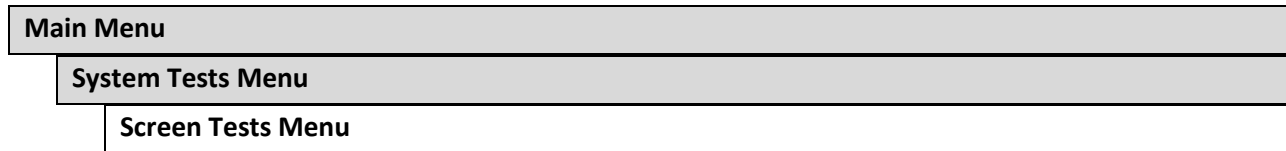

Terminator Salvation™ 32" Dedicated Game

Main Menu

System Tests Menu

Screen Tests Menu

Color Adjustment

This color bar screen of gray, yellow, cyan, green, magenta, red and blue helps identify missing colors. Missing color bars may indicate bad video RAM in the PC, or a problem with the monitor.

Color bars can also help

- Peak the brightness and black levels
- Balance red, green and blue drives
- Check purity problems (color contamination)
- Compensate for barrel or pincushion distortion
- Adjust size controls
- Test for video noise sources (such as bad cables)

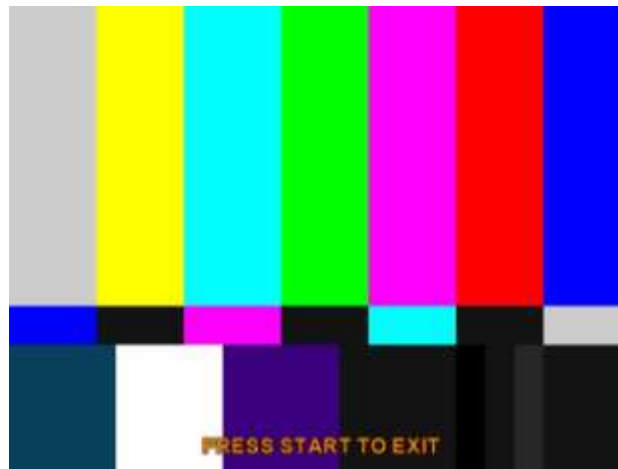

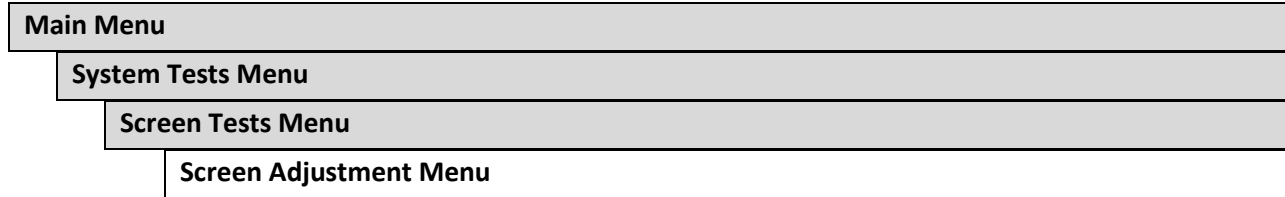

This crosshatch screen adjusts width and height, static convergence and purity, brightness and focus.

Width and Height Adjust height and width of the crosshatch pattern until the grid fills the screen. Keep all the lines visible, though. If part of the grid goes off the screen, then the game image will, too.

Static Convergence and Purity All lines in the crosshatch pattern must be white. Else, there is a convergence or purity problem. Slight color tinges at the extreme edges of the screen are okay.

Brightness Ensure the bars are a fairly strong white.

Focus Bars with fuzzy edges indicate a focus problem. Adjust the focus control for best sharpness.

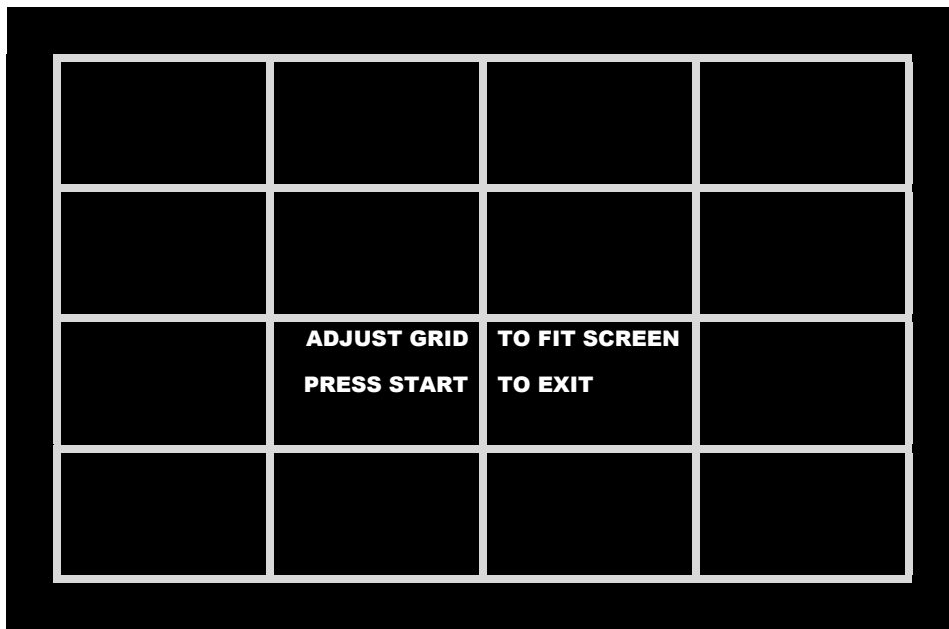

These are solid, one-color images that help adjust color drive controls for proper intensity. The screens are black, white, red, green and blue. Press the Start button to cycle through the screens. The white screen helps adjust brightness and color output balance.

Terminator Salvation™ 32" Dedicated Game

Main Menu

System Tests Menu

Sound Test Menu

This checks sound volume and quality. Missing sounds indicated digital flaws. Distorted sounds suggest analog flaws. Lack of sound suggests disconnected or bad cables or speakers.

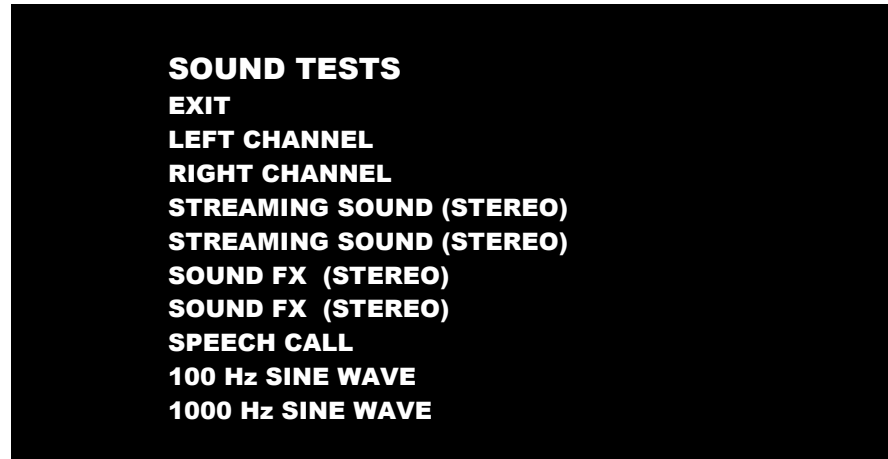

- LEFT CHANNEL AND RIGHT CHANNEL play a gunshot on each speaker.
- The first and second STREAMING SOUND plays a background music track.
- The first and second SOUND FX plays a sound affect.
- SPEECH CALL plays a vocal line.
- 100 and 1000 Hz Sine Waves generate specific frequency sounds. Cancel these sounds by selecting another test.

Main Menu

System Tests Menu

File Tests

This tests the integrity of the contents of the hard drive, searching for corrupt or missing game files. Damaged or missing files register as failed and are listed. The only solution to this problem is to restore the system from the DVD-ROM, as described in the Restore the Hard Drive section.

Main Menu

System Tests Menu

Coin Meter Test

In this test, the System Tests Menu is the bottom-level menu. Watch the mechanical coin meter, which should increment by one count. If it does, it has passed the test. If it does not, it may not be receiving a pulse from the game. See Troubleshooting for more details.

Main Menu
System Tests Menu
Cabinet Lamps Test

This test turns the five different cabinet light lines on and off, cycling through left and right start buttons, the left and right holsters and the T-600 eyes with subwoofer.

Main Menu
System Tests Menu
Watchdog Test

This tests the Watchdog circuit, which protects the game against screen freezes (infinite loops). After a countdown, the game resets. To exit before the reset, press either Start or Volume button, squeeze a trigger or pump a gun. If the test succeeds, the game resets normally. If the test fails, the reset process loops or ends abnormally. See the Troubleshooting Chapter to diagnose and correct this problem.

If the watchdog is disabled, the countdown will finish with no result.

Main Menu
Collections

COLLECTIONS	
EXIT	
SEND COLLECTIONS MESSAGE	
SHOW COINUP FEE DETAILS	
LAST COLLECTION DATE	NEVER
GROSS COLLECTIONS	\$0.00
COINUP FEES	\$0.00
NET COLLECTION	\$0.00

Send Collections Message contacts the server and delivers the latest collections information, zeroing out local coin data.

Show Coinup Fee Details shows costs related to advertising, communications and upgrades.

Gross Collection is the total amount of money the game has earned since last collection.

CoinUp Fees should match total from CoinUp Fee details.

Net Collection is Gross minus Fees.

Main Menu
View Log Menu

This lists history of significant events or errors in file system.

Terminator Salvation™ 32" Dedicated Game

Maintenance

Hard Drive Recovery

Symptoms requiring hard drive recovery include

- File Test reports bad or missing files.
- Game fails to finish loading during startup.
- After resetting the AC power, an error is reported.
- You are prompted to insert a boot DVD.
- Erratic Game or Attract Mode.
- The following screen:



To identify corrupt files, press Test, choose System Test Menu and run the File Test.

The only way to repair corrupt files is to recover the hard drive, as detailed below.

COMPUTER

The computer contains sensitive components, including a hard drive. Do not handle roughly. Call your distributor before servicing its internal components. Ask about warranty information as it relates to the PC.

Do **not** use the PC on/off switch. Turn AC power on or off with the cabinet power switch.

1. With game and PC on, verify that the RIO board has power. If not, see Troubleshooting.
2. Open the Coin door.
3. Open the PC DVD-ROM tray by reaching back to the PC and pressing the Open/Close button on the drive bay.
4. Insert the first of two restore DVDs (labeled *Disc 1*) into the tray.
5. Close the tray by pressing the Open/Close button again.
6. Turn cabinet power switch to OFF. Wait 30 seconds.
7. Turn cabinet power switch to ON.

8. Recovery begins automatically when PC boots up.
9. If recovery does not begin, check to ensure disc is inserted correctly and is not damaged.
10. Initial software loading may take several minutes. Check progress periodically.
Do not interrupt power or reset the game during recovery.
11. At some point, the game will eject *Disc 1* and prompt you to insert *Disc 2*.
Swap discs and close the tray.
12. When software has been loaded, a message indicates that restore is complete. When instructed to remove *Disc 2*, open DVD-ROM drive tray and remove *Disc 2*.
13. Turn cabinet power switch off.
14. After 30 seconds, turn cabinet power switch on.
15. Game will reboot and enter calibration mode.
16. Re-calibrate guns.

BIOS Settings/Power Management

NOTICE

The PC ships with correct BIOS settings. Making changes to the BIOS different from the description below may adversely affect game functions.

This BIOS setting lets the PC automatically power up. With the setting enabled, the PC reboots when it detects AC power. This eliminates the need to manually turn the PC back on after power disruption.

Do **not** use the PC on/off switch. Turn AC power on or off with the cabinet power switch.

1. Turn cabinet power switch off.
2. Open rear of cabinet.
3. Connect a USB keyboard to the PC.
4. While holding the Delete key on the keyboard down, turn cabinet power switch on.
5. When the BIOS menu screen appears, make the following adjustments.

Feature	Set to
Standard CMOS Feaures > Drive A.....	[none]
Standard CMOS Features > HALT ON.....	[No Errors]
Advanced BIOS Features > Boot Sequence.....	1 st CD-ROM 2 nd Hard Disk
Advanced BIOS Features > APIC Mode	Disabled
Advanced Chipset Features > Frame Buffer	[16M]
Advanced Chipset Features > PMU > CPU Frequency	[200.0]
Power Management Setup > PWRON After PWR-Fail.....	[On]

6. Follow instructions on screen to save and exit.
7. PC will reset and load the game.

Terminator Salvation™ 32" Dedicated Game

Opening the Gun Case

Open the gun case to service the trigger, buttons, and coil assembly. You do not need to open the case to service the pots that aim the gun.

- 1 To open the gun case, first remove the 12 Torx security screws shown by the single arrows in the picture below, and remove the corresponding nuts from the other side of the gun.
- 2 Remove the four screws shown by the double arrows in the picture below. These screw into the frame, so there are no nuts to remove.
- 3 Carefully remove the left side cover from the gun, being careful not to pull the wires from the grenade button on the cover. The wires are long enough that you can set the cover on the control panel near the gun without disconnecting the wires.



Closing the Gun Case

- 1 To close the gun case, first align the slots that fit around the gun PCB (with the LED display), and then carefully put the two halves together. Make sure no wires or components get caught or pinched. Pay special attention to the area around the trigger and spring, the wires coming out of the frame shaft, and the wires attached to the coil and barrel light.
- 2 Insert the four (4) 3/8" x 10-32 screws shown with the double arrows. Partially tighten all four screws, verify the case is mating properly, and then tighten the screws snugly.
- 3 Check the trigger to make sure it works properly. The trigger or spring could shift while you are assembling the case.
- 4 Replace the remaining 8-32 screws and nuts, shown by the single arrows above, and tighten snugly. The screw at the top of the muzzle end is 3/4" long, and the two screws in the handle are 1" long, as shown above. All of the other screws are 1 1/4" long.

Gun Trigger Service

To replace the trigger spring, refer to the picture below for its placement in the gun housing.

- 1 Install the plastic trigger so it presses against the spring, and the bottom part of the trigger will press the switch actuator when a player pulls the trigger.
- 2 To replace the micro switch, remove the two screws that secure the switch in place. Remove the two wires and install them on the same terminals on the replacement switch.
- 3 Connect the signal wire to the NO connector (middle connector) and the black ground wire to the C connector.

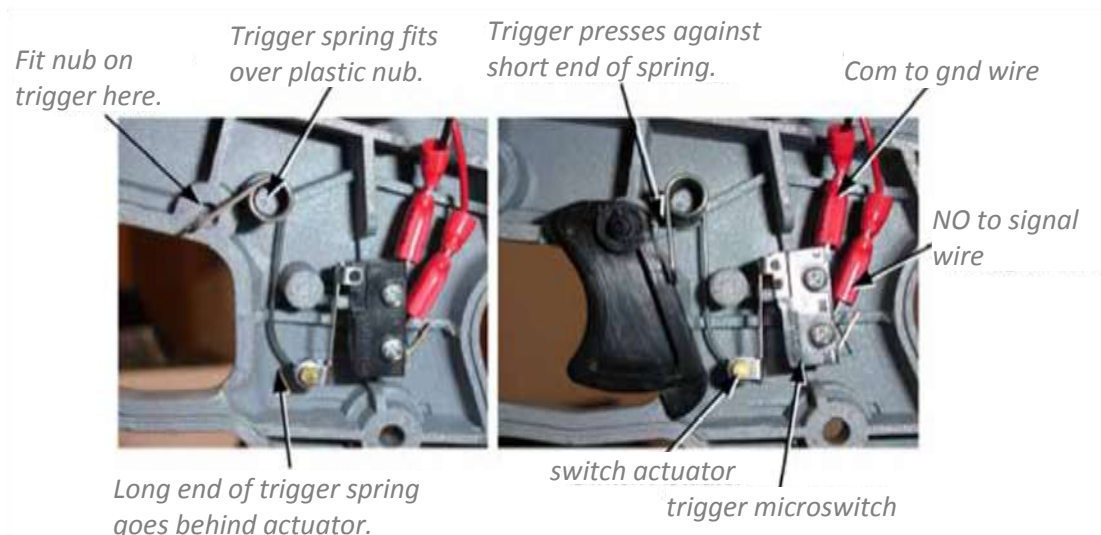

Trigger Mechanics and Wiring

Gun Button Service

These instructions explain service for components of the lighted buttons.

- 1 If you replace a button micro switch, connect the signal wire to the NO (middle) connector and the black ground wire to the C connector. Failure to do so will cause the button to not work.
- 2 To replace the LED bulb, pull the lamp assembly straight out of the button housing, and then pull the bulb straight out of the lamp housing. The two lamp wires are interchangeable and can connect to either terminal on the lamp housing.

Gun Coil Assembly Service

The coil assembly provides the force-feedback recoil when the gun is fired. Perform the following steps to replace components of the coil assembly:

- 1 Open the gun case as described earlier.

Terminator Salvation™ 32" Dedicated Game

- 2 Remove the two screws shown below from the right side of the gun.



Two Screws on Right Side of Gun

- 3 Remove the nut that secures the ground wire to the ground lug on the side of the coil assembly mounting plate, as shown below.
- 4 Remove the two screws that secure the coil assembly mounting plate to the gun shaft, as shown below.



ground wire to ground lug
NOTE: You must reconnect this wire.

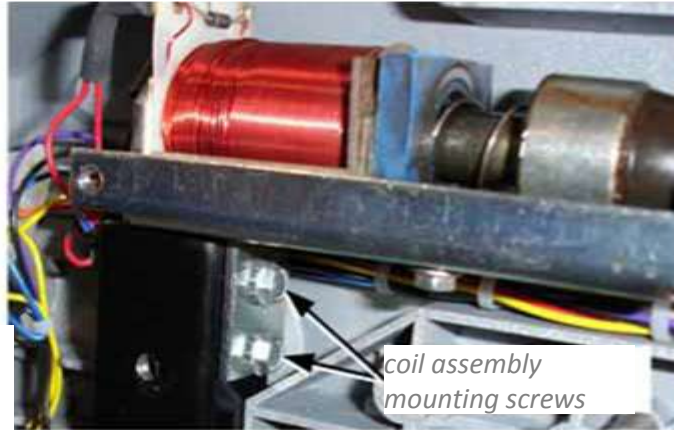

coil assembly mounting screws

Coil Assembly in Gun

- 5 Reverse the steps to re-install the coin assembly. Be sure to secure the ground wire to the ground lug on the coil assembly mounting plate.

Gun Pot and Gear Service

Each gun has two pots that measure the movement of the gun on the X-axis (left and right) and Y-axis (up and down). The X-axis pot is located under the gun base below the trigger. The Y-axis pot is located on the side of the gun base below the reload button.

Use the Gun Test & Calibrate screen from System Tests in the Operator menu to test gun motion. To test a pot, power off the game and test resistance at the pot. When you move the gun, you should see a steady linear increase or decrease in resistance, with no jumps. Replace the gears if they are worn or cracked.

Perform the following steps to replace a pot or gear shaft:

- 1 Remove the six (6) Torx security screws that secure the front and rear covers over the gun base, and remove the covers.
- 2 Remove the two mounting nuts and remove the metal mounting plate from the pot to be replaced.
- 3 Use an Allen wrench to loosen the set screw from the gear shaft, and remove the gear shaft.
- 4 Using a 1/2" wrench, remove the nut and lock washer that secure the pot to the frame.
- 5 De-solder the wires from the pot and solder them on the same terminals on the replacement pot.
- 6 Install the new 5K Ω pot with the same orientation. Make sure that the plastic keys on the pot mate properly with the metal.
- 7 Re-install the lock washer and nut, being careful not to over-tighten.
- 8 Re-install the gear shaft and tighten the set screw.
- 9 Calibrate the gun using the Gun Test & Calibrate screen from System Tests in the Operator menu after replacing a pot.

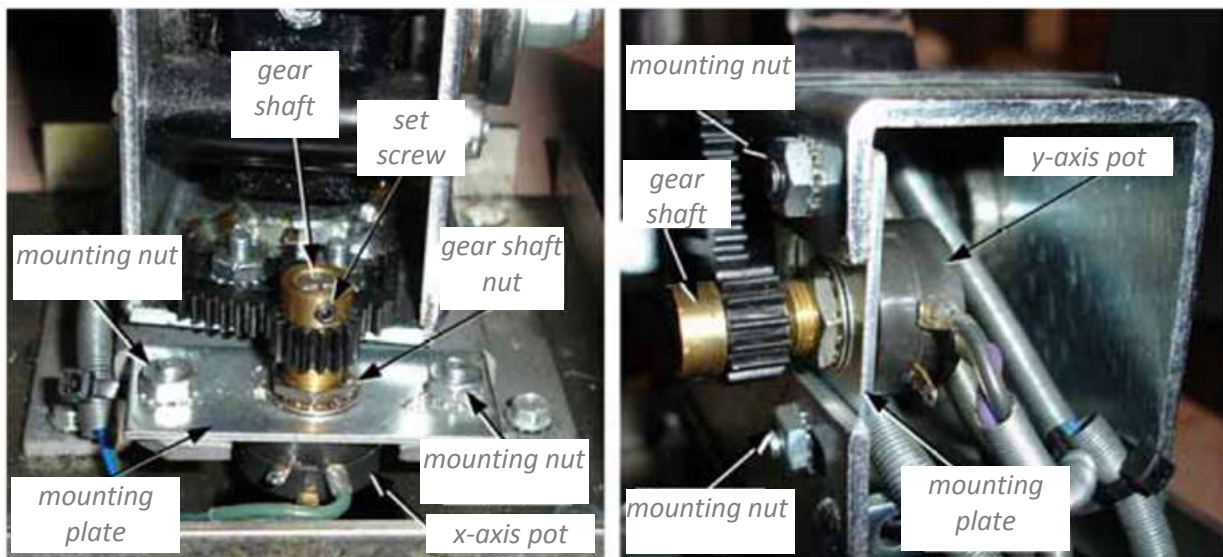

Gun Gears and Pots

Gun PCB

The gun driver board is mounted remotely in the cabinet and controls the voltage to the gun coil. There is one for each gun.

POTENTIAL PCB DAMAGE

Disconnect the cabinet from AC power before making any connections to the gun PCB. Hot-plugging any connector will damage the PCB.

Terminator Salvation™ 32" Dedicated Game

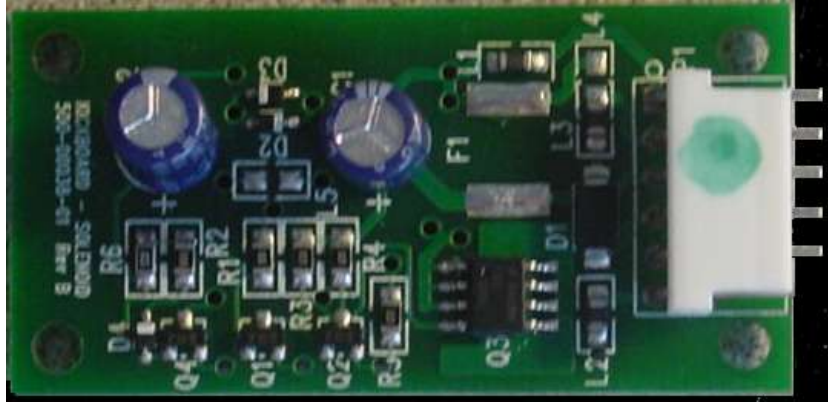

Gun Driver Board

Start Button Service

The Start buttons for each player are illuminated with 12-volt lamps. Perform the following steps to replace the buttons, lamps, and micro switches:

- 1 Disconnect the cabinet from AC power.
- 2 Open the coin door and reach up under the control panel to access the buttons.
- 3 To remove a micro switch, gently rock it to the side and remove it from the housing. Remove the wires and install them on the same connectors on the new micro switch.
- 4 To remove the lamp housing, gently rock the white plastic housing from side to side to pop it out of the button housing.
- 5 To remove the button from the control panel, unscrew the retaining ring from under the control panel.
- 6 To remove a lamp from the housing for replacement, pull it straight out of the lamp housing.
- 7 When connecting the wiring to the micro switch and lamp, refer to the labels on the wires and the image below to make sure the connections are correct.

MICROSWITCH CONNECTION

Do not connect the 12-volt lamp power wire to the micro switch. This could damage the BVRI/O PCB.

- 8 Reverse these steps to install the replacement button and micro switch. Connect the ground wire to the COM connector on the bottom of the switch housing, and the signal

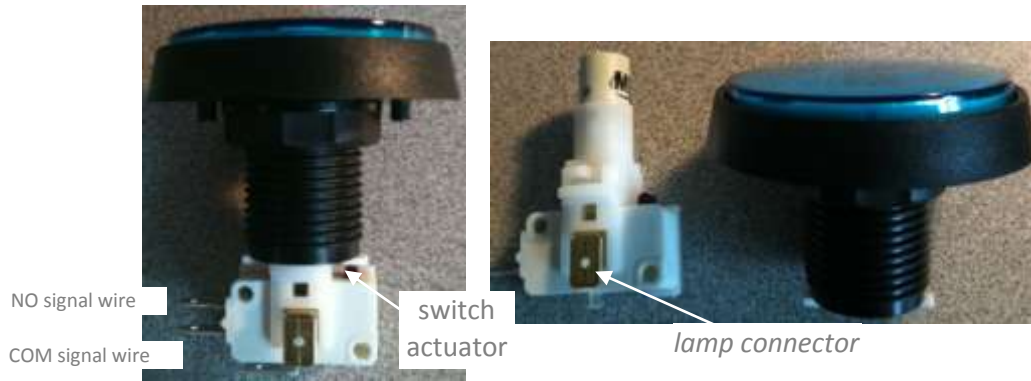

Assembled button (left) and disassembled button (right)

Marquee Florescent Light Service

The marquee is lit by a florescent fixture. To gain access to the marquee fixture, remove the three (3) wood screws and five (5) nuts with washers from the back of the marquee, and then remove the marquee front with the artwork and clear plastic.

Replace the florescent tube with another 18" florescent tube.

To remove the fixture, disconnect the cabinet from AC power. Disconnect the AC power cord from the fixture. Remove the two Phillips screws that secure the fixture to the cabinet and remove the fixture.

Cold-Cathode Fluorescent Light Service

The cold-cathode florescent lighting is used to add dramatic lighting effects to the cabinet.

Note: If both lights in a set fail, make sure the power connector is firmly attached to the power inverter. Connect the lights to another power inverter to test them. Replace the power inverter if faulty; it is held in place with Velcro and/or cable ties.

Light Location	Size and Qty	Changing Tube(s)	Inverter Location
Kick Panel	One 12" red tube	Remove the four screws that secure the instruction panel in place.	Cabinet floor
Area below guns	Two 6" red LEDs; one below each gun		Beneath gun mounts
Speaker	One 12" tube	Remove the four screws that secure the instruction panel in place.	Inside cabinet on side wall
Marquee	18" traditional florescent	Remove three screws and five nuts with washers, then the marquee front	

Power: Connections, Fusing and Filtering

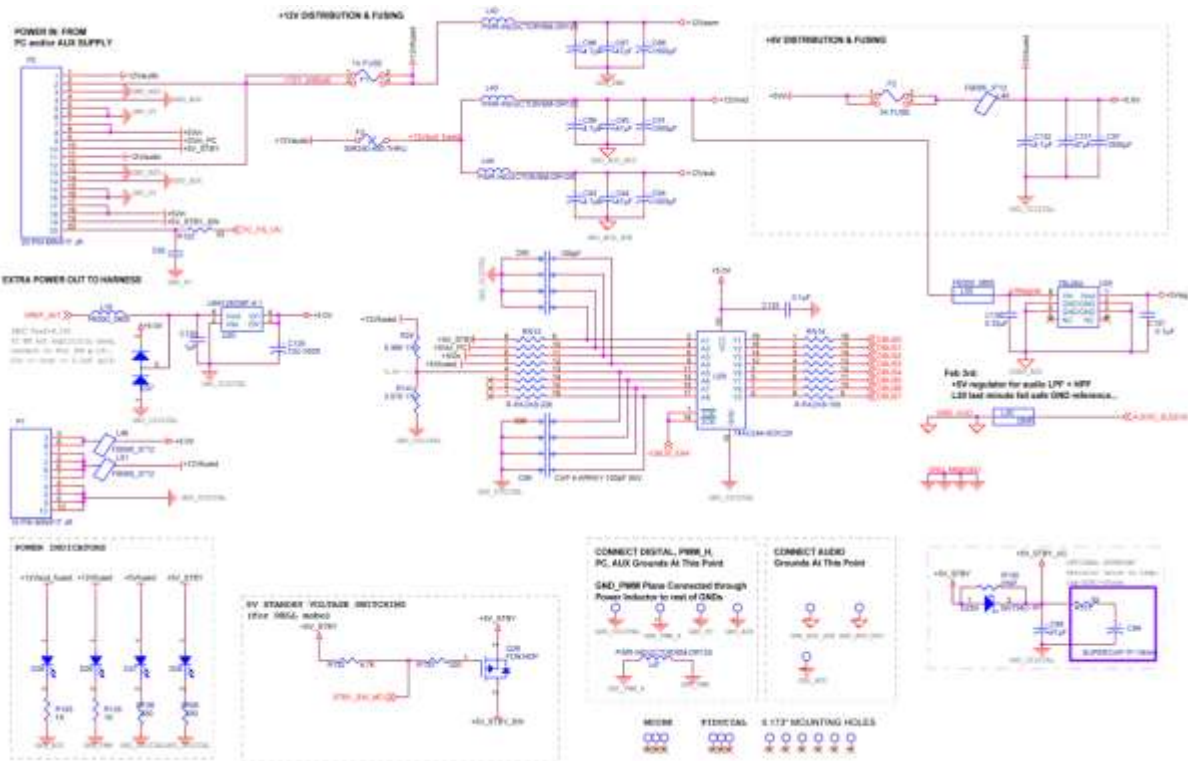

Discrete Outs: High-Current Outputs (3A open drain)

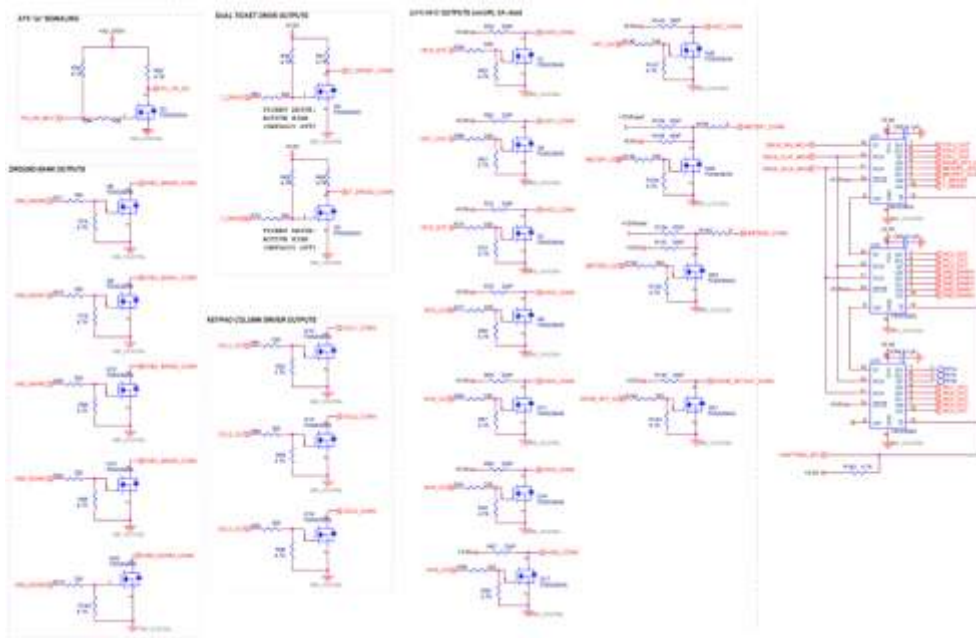

Terminator Salvation™ 32" Dedicated Game

MCU: JM32, USB Supercap-backed devices

ALL DEVICES ON THIS PAGE ARE POWERED
BY SUPERCAP BACKED 5V STANDBY

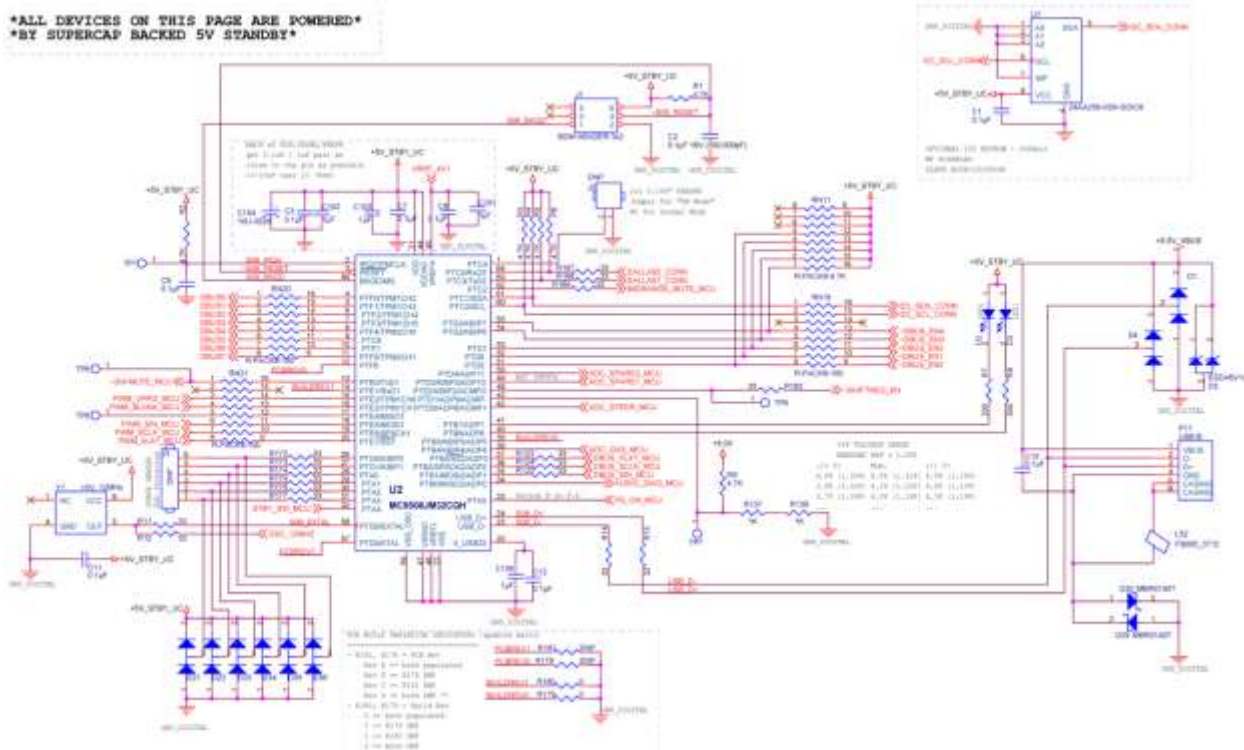

Audio

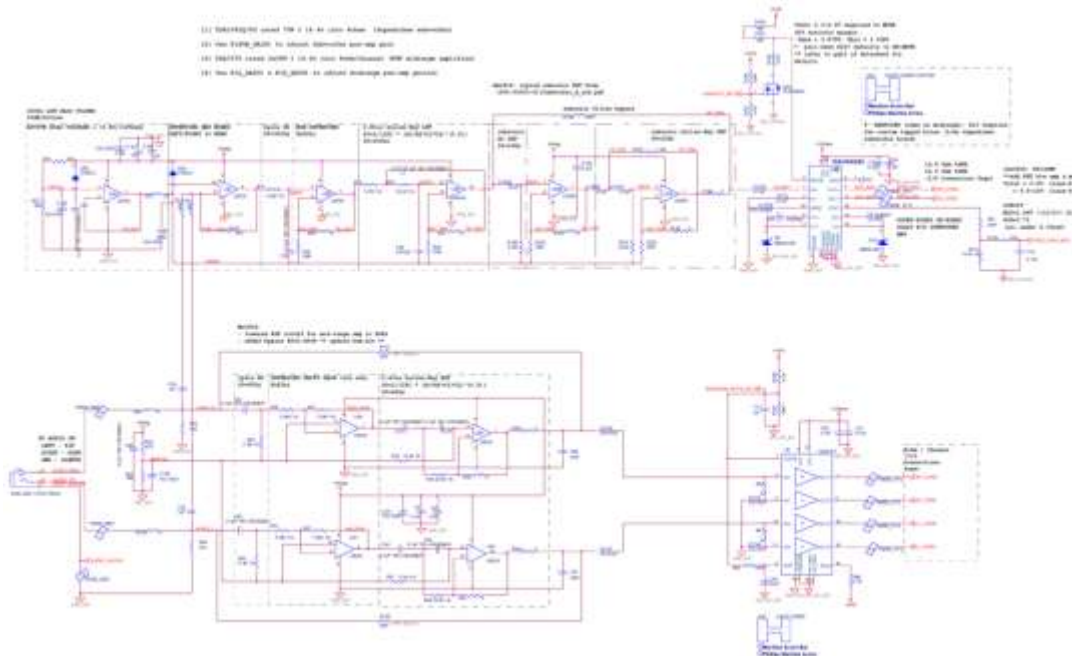

PWM Logic and Output Drivers

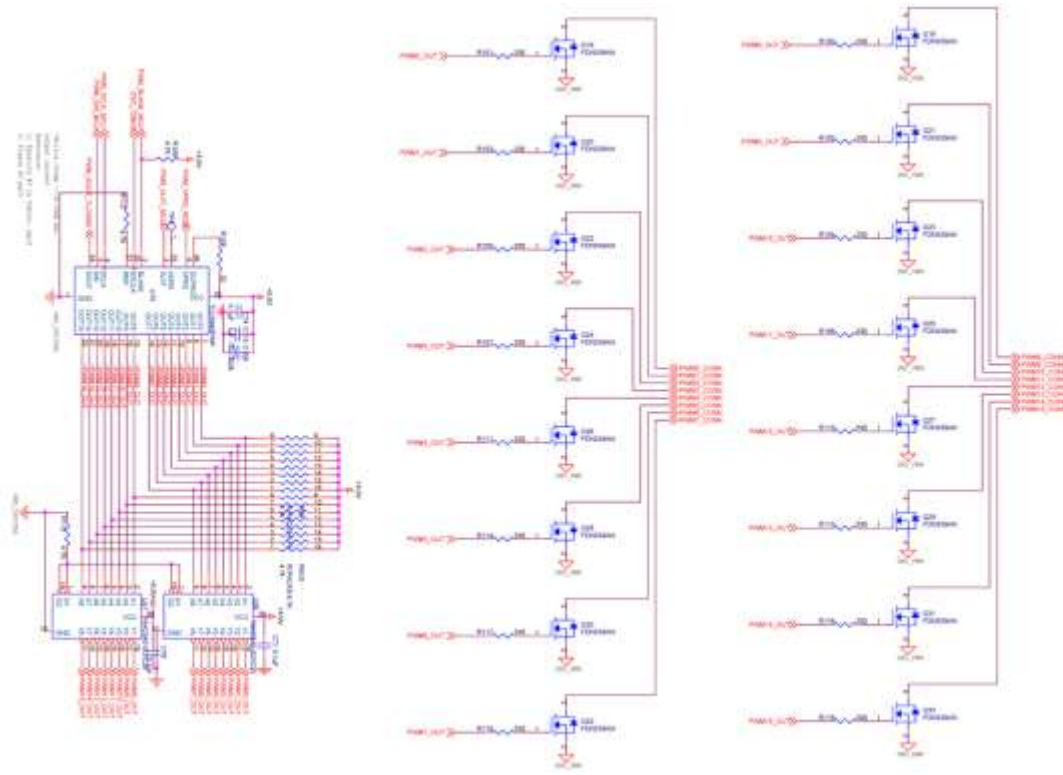

I/O Connectors

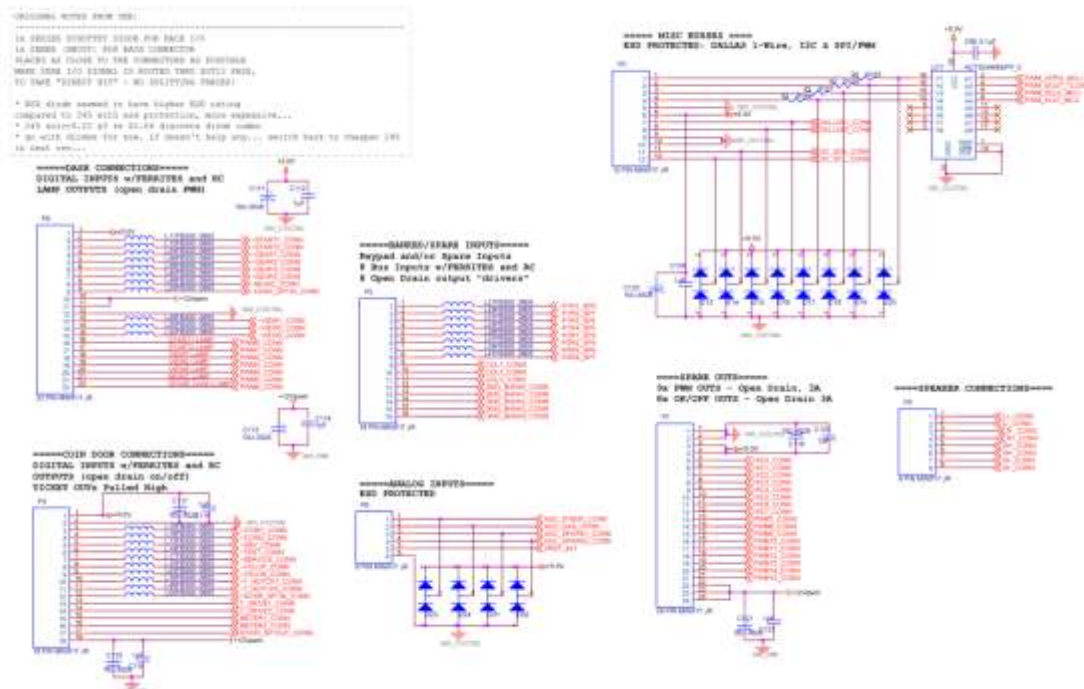

Gun Parts and Wiring

Exploded Cabinet

LETTER	PART NAME	PART NO
A	MARQUEE FRAME	600-00591-01
B	18" FLUORESCENT BULB - 15W	
C	STARTER FS-2	
D	FLUORESCENT FIXTURE COVER	
E	MARQUEE	600-00576-01
F	#8-32 x 1/2" BLACK BUTTON HEAD P.I.T. SCREW (QTY 6)	
G	#1/4-20 x 1.25" BLACK BUTTON HEAD P.I.T. SCREW (QTY 3)	
H	LCD	
I	#6-32 X 3/8" PAN HEAD PHILIPS SCREW (QTY 6)	
J	TEMPERED GLASS 18" X 30.5" X 3/16"	600-00584-01
K	FRONT BEZEL	600-00581-01
L	#10-32 X 3/8" BLACK BUTTON HEAD P.I.T. SCREW (QTY 6)	
M	#1/4-20 X 1" BLACK BUTTON HEAD P.I.T. SCREW (QTY 4)	
N	1/4" BLACK SPLIT LOCKWASHER (QTY 7)	
O	1/4" BLACK WASHER (QTY 7)	
P	#8 x 3/4" BLACK BUTTON HEAD T.I.P. SCREW (QTY 4)	
Q	WOOFER GRILL	600-00585-01
R	6.5" WOOFER SPEAKER 4 OHMS	

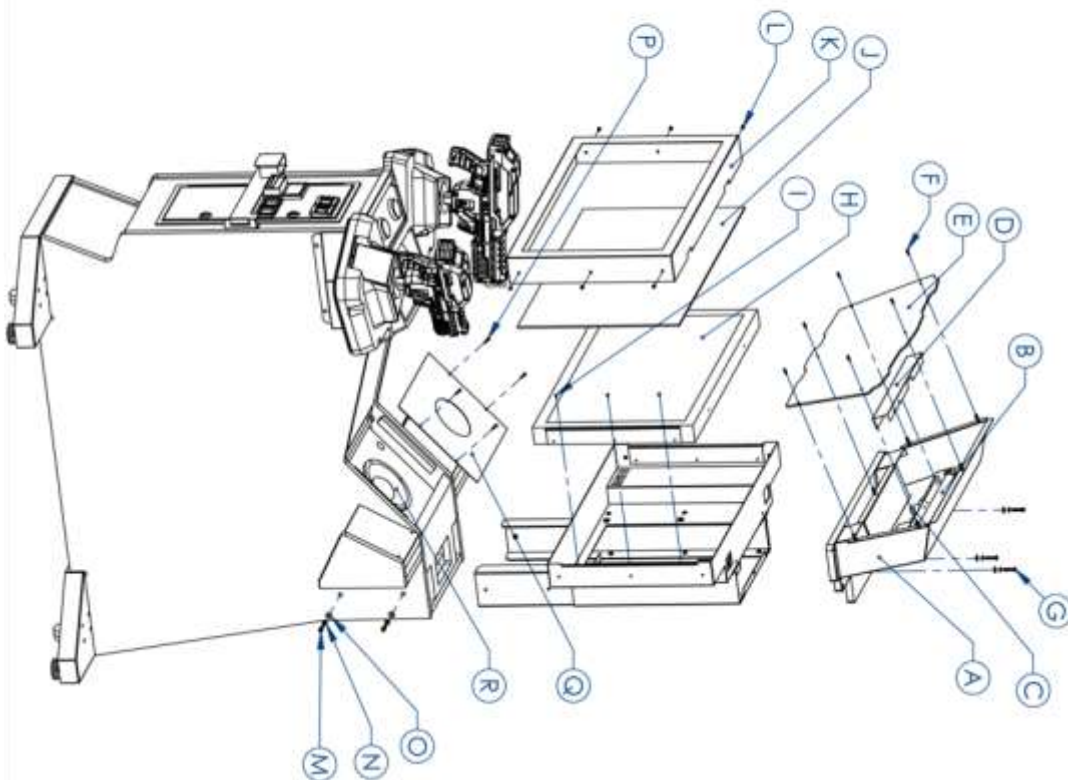

Terminator Salvation™ 32" Dedicated Game

Gun Mounting

LETTER	PART NAME	PART NUMBER
A	GUN	820-00013-00
B	FRONT GUN SHROUD RIGHT / LEFT	600-00606-01 / 600-00607-01
C	REAR GUN SHROUD	600-00593-01
D	#8-32 X 1/2" (QTY 5) BLACK BUTTONHEAD P.I.T. SCREW	
E	#1/4-20 X 3/4" BLACK BUTTON HEAD P.I.T. SCREW	
F	1/4" BLACK SPLIT LOCKWASHER	
G	1/4" BLACK WASHER	
H	#1/4-20 X 3/4 (QTY 4) HEX HEAD WITH KEPS	

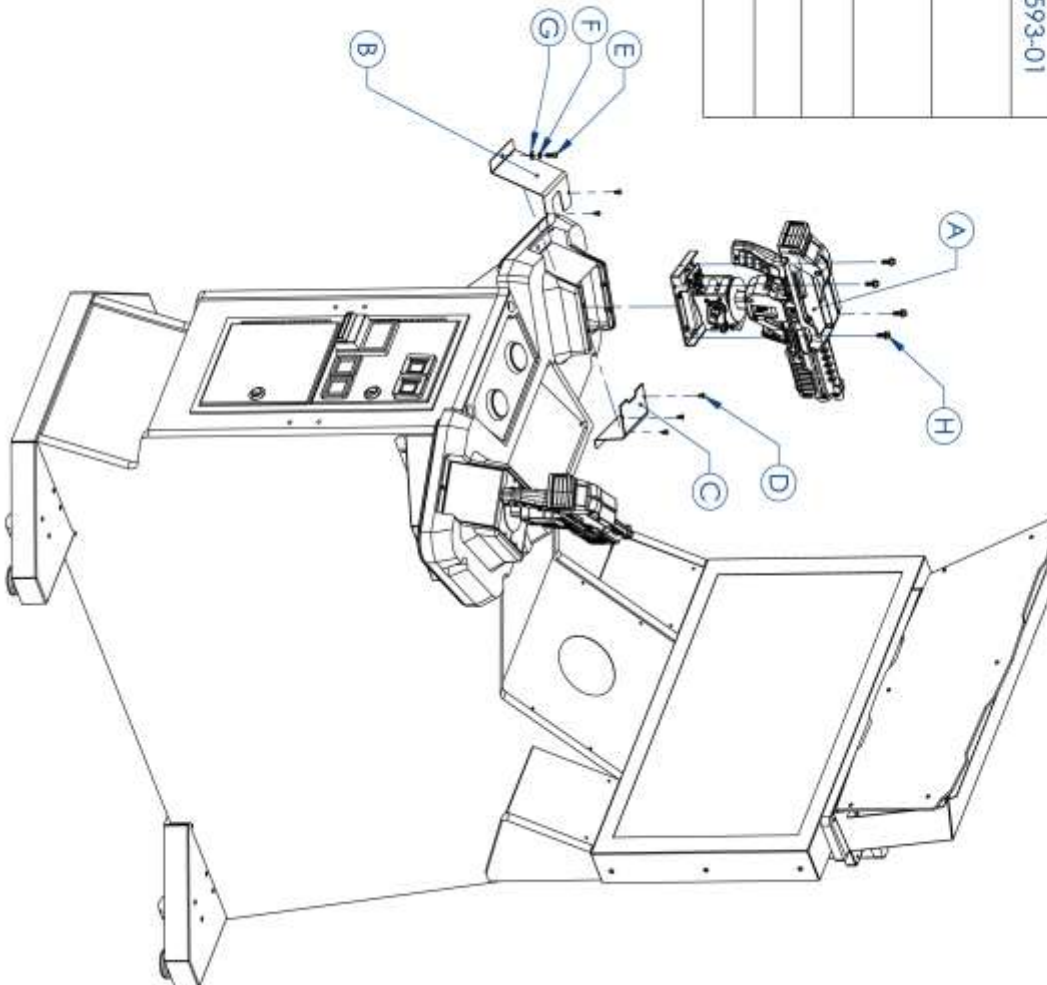

QTY	DESCRIPTION
1	94-0854-30 BOTTOM AND BASE BRKT SUBASSEMBLY WITH BUMPER FIT/DELUXE
2	94-0854-30 BRKT SUBASSEMBLY W/HANDLE & MFG BRKT COLL PADS 14 DELUXE
3	94-4822-00 SHIRT 5/8 DIA
4	94-4827-00 GEAR SEGMENT W/HUB
5	94-4840-00 SPACER SEGMENT GEAR
6	43-0092-00 NUT KPS 3/32
7	43-0092-00 3/8 SAE ELA WASHER ZNC PLTD
8	43-0092-00 NUT 3/16 14 NYLON
9	43-0092-00 LOCKWASHER EXT #10
10	43-0353-00 NUT HEX 10-32 BUN NYLON ZINC PLATED
11	94-4824-00 BRACKET FOOT MFG HORIZONTAL
12	94-4913-00 BRKT FOOT MFG VERTICAL
13	94-4914-00 LONG LIFE BOT W/NUIT T WSRG SR
14	94-1094-00 LEFT GUN HALF FRAM THRILLS 14 DELUXE
15	94-1094-00 RIGHT GUN HALF FRAM THRILLS 14 DELUXE
16	94-1094-00 SWITCH ASSY BALL DETECT
17	75A-1012-20 FRM W/SUB MAIN SW CIR RED RD CAP DB MS 12V WHT LED LAMP
18	94-2515-04 TRIGGER BLACK NRS STYLE
19	94-0005-00 SPRING TRIGGER RETURN
20	77-2N10-57 VIT BUTTON REC ARMOR NO LED
21	43-0280-00 HEX HEAD CAP SCREW 10-32 X 1.14
22	43-2327-00 SCREW 10-32 X 3/8 B.H TORX TP BLACK OXIDE
23	94-2514-00 NUT 8-32 HEX NYLON BLACK
24	43-0214-00 NUT 8-32 HEX NYLON BLACK
25	4008-01100-12 SCREW 8-32 X 3/4 TORX
26	43-0099-00 SCREW 8-32 X 1/2 BUNAS TORX
27	43-0127-00 SCREW #2 X 1/2 TYPE 8 PH
28	94-0851-10 COVER FRAM THRILLS 14 DELUXE
29	94-4817-01 GEAR 32DP LIT 25 BORE 5 LONG
30	43-0011-00 SET SCREW 6-32 X 3/4 CHP POINT
31	94-1090-10 LED LIGHT TUBE FRAM THRILLS 14 DELUXE W/CONN

NOT SHOWN:
 1] 94-1081-00 - MAIN HARNESS QTY 1
 2] 90-1013-00 - TE WRAP 4" QTY 10
 3] 43-0127-00 - SHRINK TUBING 1/8 QTY 6
 4] 96-0703-01 - TUBING HEAT SHRINK 3/16 X 3/4 QTY 2

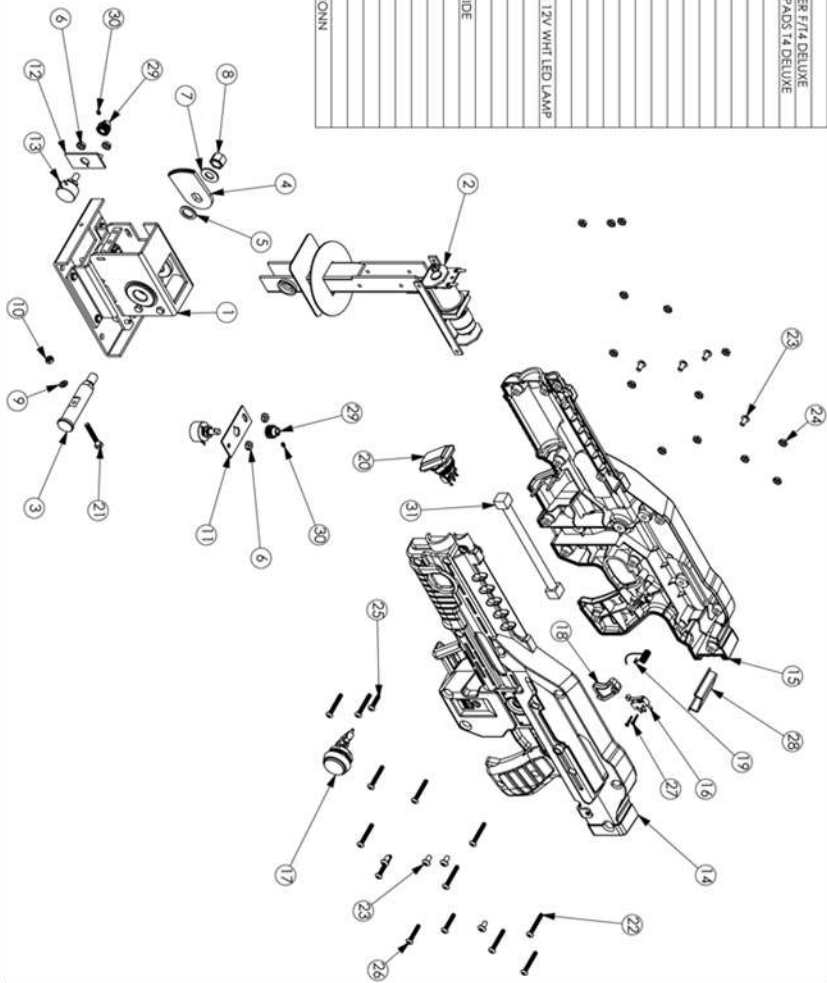

Gun Wiring

- NOTES
- 1) UNLESS OTHERWISE NOTED, ALL WIRES ARE BOMBS, STRIPPED, UL TYPE 1007, 30KV, VW-L 80 DEG. C. PVC INSULATION.
 - 2) THE WIRES TO BE RAISED AT BENDS/JOINTS, SPECIFIC LOCATIONS AS INDICATED BY DIMS. AND EVERY 3" TO 4" AS NOTED.
 - 3) STRIP WIRE PROTECTION - MATERIAL: 1.002" DIAMETER, THINER, HARD BRASS, PRE-PLATED, 021 D.D. 0265 LIT.

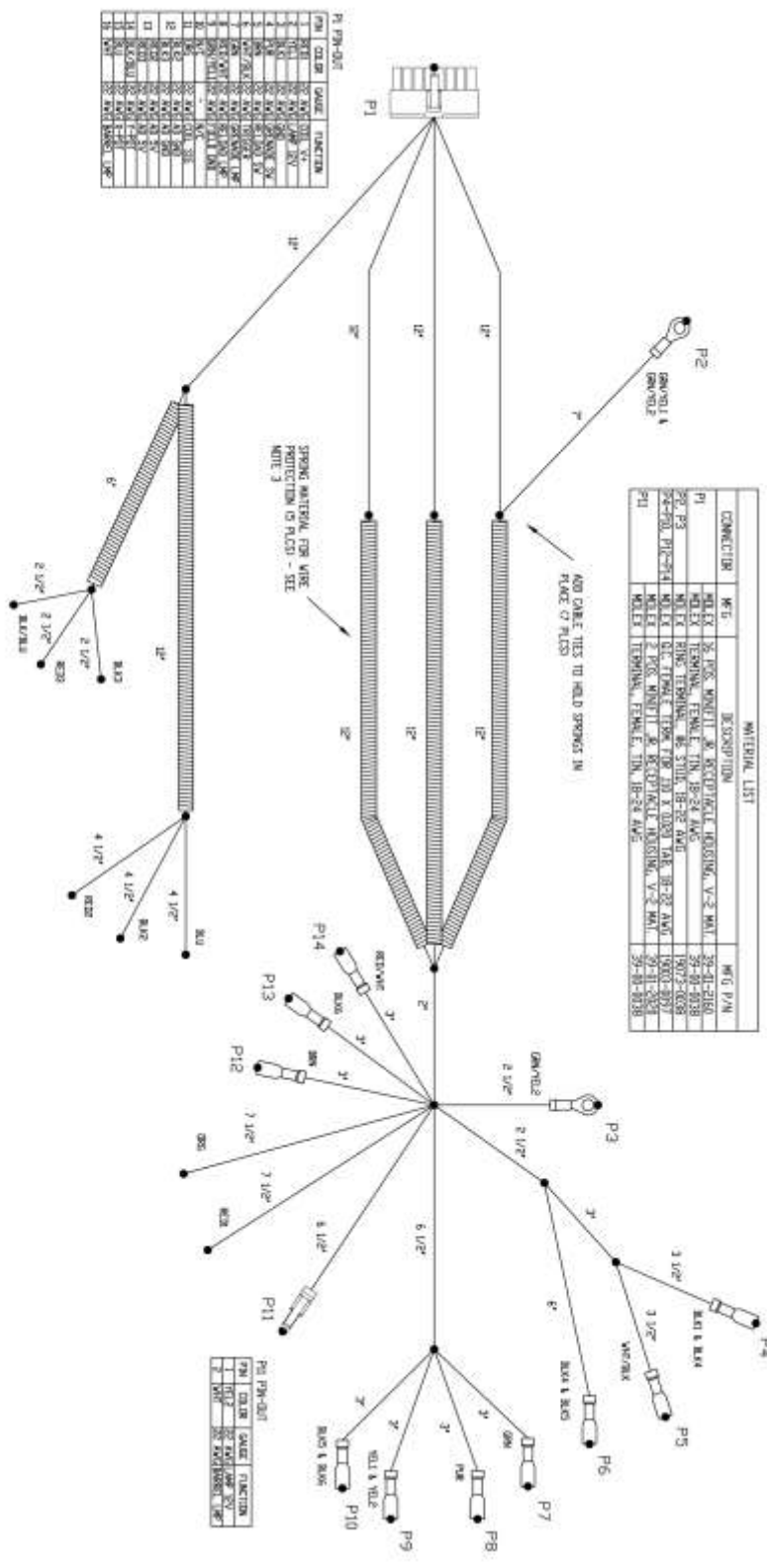

- 4) ALL UNTERMINATED WIRE ENDS TO BE STRIPPED 3/16" AND TINNED.
- 5) ALL CONNECTOR MATERIALS PER MATERIAL LIST TABLE OR APPROVED EQUIVALENT.
- 6) ASSEMBLY MUST COMPLY WITH EU DIRECTIVE EN60950/CE (EMC).
- 7) ALL DIMENSIONS ARE BETWEEN DIMS.

Terminator Salvation™ 32" Dedicated Game

Troubleshooting

Warning: Review safety chapter before making any adjustments to game.

Problem	Possible Cause	Solution
Game will not power up.	Game not plugged in	Plug game into AC outlet.
	Game not turned on	Turn on main power switch.
	Game fuse is blown.	Check and replace fuse.
	No power to receptacle	Test AC outlet and plug game into powered outlet.
	PC not turned on.	Turn PC power switch on. Ensure IEC cable tightly plugged in. Trace cable back to source to ensure continuity.
	PC BIOS set incorrectly.	See BIOS Settings chapter.
Scrambled or scrolling display	Sync polarity incorrect.	Change DIP switch settings for HSYNC and VSYNC.
NO VIDEO message	Video cables not plugged in properly	Reattach and tighten power and video cable to monitor.
Buttons do not work	Faulty micro switch	Replace the micro switch on the button and re-test. Verify that the wires are connected to the correct spades on the micro switch
	Faulty wiring	Disconnect the cabinet from AC power. Verify that all wires are firmly connected to each button and the PCB. Verify that no wires are frayed or improperly shorting to ground. Verify that wires are connected to the correct spades on the micro switches.
	Faulty PCB	Ensure all connections to PCB are secure. Replace PCB if faulty.
Neither buttons nor audio work	PCB connected to faulty USB port (boot message may indicate not detected)	To test a USB port, turn off the game, disconnect the device from the port, and then connect the game dongle to the port. Reboot the game. A No Dongle message indicates the port is bad. If the game starts, the port is working. After the test, reconnect all devices to the correct USB ports and reboot.

No sound or bad sound	Bad connection	Check connection to speakers.
	Volume set too low	Use VOL UP button on Test panel to raise volume
	Faulty wiring	Verify all wires are firmly connected to the speakers, PCB, and green computer audio port. Verify that each wire is connected to the correct port and no wires are frayed or improperly shorting to ground.
	Blown speakers	Remove the grill and inspect each speaker for visible damage. Run the Sound Test from System Tests in the Operator Menu to verify each speaker is working.
	Reversed wires	A weak or low muffled sound is a sign of reversed speaker wires. Check for reversed wires on each speaker.
	Faulty PCB	To verify audio is working at the computer, connect stereo headphones to the green computer audio port.

Constant low audio hum	Faulty power supply	Check external DC supply and the PC supply.
	Open ground	Check all ground wires in cabinet. Ensure AC wall outlet is properly grounded

Cold cathode tubes flicker or fail to light.	Bad connection	Check for snug connection at inverter or under topper bracket.
	Loose end caps	Tighten end caps.

Game does not load.	Hard drive failure	Recover hard drive. See Hard Drive Recovery procedure in Maintenance section.
Hard drive test reports "bad" or "missing" files.		
Game fails to finish loading.		
After resetting, game still reports an error.		
Game suggests inserting a boot DVD.		
Erratic game mode or attract mode.		
<p style="text-align: center;">WARNING! Data Files Corrupted. (Game Operation May Become Unstable.) Use "Test" Switch to Enter Test Mode and Run "File Test." Press Start To Continue.</p>		

Terminator Salvation™ 32" Dedicated Game

Problem	Possible Cause	Solution
Game resets.	Bad file.	Run File Test. Restore hard drive.
Coin meter does not click during Test.	No pulse to meter	Check wiring from meter to RIO board
	Faulty meter	Replace coin meter
Improper number of credits given when coins or bills are inserted	Incorrect setting in Adjustments	Adjust settings
	Faulty wiring	Disconnect cabinet from AC power. Verify wires are firmly connected to coin mech and bill validator and ground wires are properly connected. Verify no wires are frayed or shorting to ground.
	Faulty coin mech	Verify coin mech is not jammed. Ensure coin mech is properly aligned and latched to coin door.
Coin meter does not work	Blown fuse(s) on PCB	Replace 5A fuse(s) on PCB
Exits Test Mode every 3 seconds	Test button stuck in ON position	Slide or toggle button off after Test Menu appears
<i>No Signal</i>	Video or power cable not secure	Check and secure cable.
	PC not turned on	Turn PC power switch on. Ensure IEC cable tightly plugged in. Trace cable back to source to ensure continuity.
	Sync Polarity incorrect	Change DIP switch settings for HSYNC and VSYNC.
<i>Dongle Not Present</i>	Dongle missing or disconnected	Find dongle cable and reseal in USB port
	Faulty USB port	Insert dongle cable in different USB port
<i>Connect RIO Board or RIO Board Missing</i>	USB cable disconnected	Check USB connection from PC to RIO board
	No power to RIO board	Check for proper voltage (+5V, +12V) at JAMMA connector
<i>Watchdog Disabled or Watchdog Failed</i>	Watchdog defeated by JAMMA I/O DIP switch	Set DIP switch 8 to OFF
	No power to Reset PCB	Connect power to Reset PCB
	Reset input to motherboard disconnected	Connect 2-pin reset connector from Reset PCB to motherboard reset pin input
	Violet or black wire from Reset PCB disconnected or faulty	Check reset wire connection to JAMMA connector.

Gun Troubleshooting

Note: Do not replace or swap guns while power is on. Shut AC power off before connecting or disconnecting any components. Failure to do so may damage gun components.

Problem	Possible Cause	Solution
Guns won't register, or functions poorly	Faulty wiring	Verify that all wires are firmly connected and none are frayed or improperly shorting to ground.
	Disconnected USB or DC power	Check all power connections. If all gun lights are off, this indicates a problem with +12 VDC power.
	Blown fuse in gun power harness	Check the fuses (MDL 2A Slo Blo) in the gun power harness.
	Faulty power supply	Verify the external DC power supply is putting out the correct voltages.
A button or trigger does not work.	Faulty micro switch or wiring	Check micro switch inside gun. Check wiring. Ensure no wires are pinched in the gun case.
No force feedback recoil in gun	Faulty DC power supply	Ensure external DC power supply puts out +24 VDC.
	Faulty coil	Check wiring. Replace faulty coil.
Gun does not aim properly	Gun out of calibration	Calibrate gun
	Faulty pot or gear	Check gun pots and gears
No crosshairs visible during play but guns are functional	Check Shooting Mode adjustment	Verify selected shooting mode has gun sight
No lights on gun	Check +12 VDC power	Check wiring and ensure external DC power supply puts out +12 VDC
Fuses blow	Pinched wires	Ensure no wires are pinched by case
	Faulty power supply	Test voltage output and replace power supply if faulty

Terminator Salvation™ 32" Dedicated Game

Connection to CoinUp® Troubleshooting

Problem	Possible Cause	Solution
Game has IP address and screen says <i>Server Ping Success</i> but Test Connection screen reports Database Ping failure or File Server Ping failure.	Firewall is blocking communication with server.	Read firewall documentation. Ensure configuration allows ICMP Echo. If router has built-in firewall, check router configuration. Enable communication on ports 7786 and 7787.
	Database or File Server is down	Wait 30 minutes and revisit Test Connection screen. If still reporting failure, call CoinUp® service.

Ethernet Connection Troubleshooting

Problem	Possible Cause	Solution
Game cannot connect to CoinUp® server. No IP address appears under Test Connections menu	No broadband internet service	Contact a local ISP to setup either cable modem or DSL service.
	Wrong router configuration	Configure router for DHCP (Dynamic Host Configuration Protocol).
	Disconnected Ethernet cable	Check that Ethernet cables are tightly connected at both ends. An audible click confirms tightness. Reboot game. In Diagnostic mode, select Online Menu then select Connection Menu then Test Connection. Confirm that IP address appears. The phrase eth0 must follow IP address.
	Faulty Ethernet cable	Test cable by connecting it from another PC into router or wall jack. Replace cable if faulty.
	Faulty Ethernet wall jack.	Plug Ethernet cable into a different jack.
	Broadband service is down.	Contact ISP.
	Faulty router	Plug Ethernet cable into different jacks in router. Plug Ethernet cable directly into DSL or cable modem instead of router. Replace router if faulty
	Faulty network card	Call CoinUp® service

Cellular Connection Troubleshooting

Problem	Possible Cause	Solution
Game cannot connect to CoinUp® server No IP address appears under Test Connections menu	Poor connection between cell modem and PC.	Check that USB connections at cell modem and PC are tight. Turn off cabinet AC power. Wait 30 seconds and reboot game. If still no connection, enter Diagnostics system and go to Connection Menu. Select Cell Modem Details. If message is <i>No Modem Found</i> or <i>Collecting Data</i> , call CoinUp® service.
	Faulty cell modem	Ensure PWR LED on cell modem glows green, which means PC is providing modem with power. If no power, swap with working modem. Check modem for obvious damage (dents, burns, smoke damage, broken connectors) If modem seems fine, call CoinUp® service.

Cell modem connection is good and IP address appears at Test Connection screen. Under Cell Modem Details, signal is weak or nonexistent.	Poor antenna location	Turn off game and move it near window or exterior wall.
	Faulty connection	Check connections between cell modem and antenna. If cable is frayed, broken or looks dried-up, replace it. Replace antenna if it appears damaged.

Terminator Salvation™ 32" Dedicated Game

Wi-Fi Connection Troubleshooting

Problem	Possible Cause	Solution
Wi-Fi Details status is <i>Not Connected</i> and Adapter is <i>Not Found</i> .	A supported USB Wi-Fi adapter is not connected.	Connect a supported Wi-Fi adapter. Turn cabinet AC power off for a minute and reboot.
	Faulty network card	Call CoinUp® service
Wi-Fi Details status is <i>Not Connected</i> , but a supported adapter is connected.	Wi-Fi network information was not saved.	Configure game to connect to Wi-Fi network at Wi-Fi Setup Menu.
Wi-Fi Details status remains <i>Locating Access Point ...</i> for more than 5 minutes.	Weak signal or interference causing delay in locating access point.	Restart cabinet AC power.
	Wireless access point or router is off or disconnected.	Ensure access point has power. Ensure it is connected to router. Restart access point. Ensure router has power and is connected to cable/DSL modem.
	Network information entered in Wi-Fi Setup does not match information stored in the wireless access point or router.	Re-enter network information. Configure game to connect to network in Wi-Fi Setup Menu. Ensure encryption type, encryption key, SSID and broadcast channel match what is stored in wireless access point or router.
Wi-Fi Details status remains <i>Obtaining IP Address...</i> for more than 5 minutes.	Weak signal or interference delaying negotiation of IP address with router.	Restart cabinet AC power.
	Wireless access point or router is off or disconnected.	Ensure access point has power. Ensure it is connected to router. Ensure router has power and is connected to cable/DSL modem.
Game has an IP address, but Test Connection menu shows that Server, Database and Fileserver pings all report failures.	Server information is outdated.	In Diagnostics Menu, select Online Menu, then select Online Debug Menu then View Online Debug Details then Server Details and finally Refresh Server Info. After refresh, new host names and IP addresses of CoinUp® servers are displayed.

CoinUp® Operation Overview

Having your Terminator Salvation™ game connected to CoinUp® allows easy access to software updates and permits game health and earnings to be monitored via coinup.com. There are three ways to connect to CoinUp®: through an Ethernet cable, a cellular modem, or a Wi-Fi connection.

Preparation

1. Open a bank debit account.
2. Fill out the CoinUp® *Authorization Agreement for Automated Payments*.
3. Read and sign the CoinUp® *Participating Operator Agreement*.
4. Read and sign the CoinUp® *Operator Registration Form*.
5. To become an authorized operator, fax the forms to (630) 348-2099 or mail them to:
Play Mechanix™
800 Roosevelt Road, Suite D-103
Glen Ellyn, IL 60137

Authorization occurs in just a few days. Login information will be sent via email.

Optional Setup Steps

- To purchase a cellular modem, read and sign the *Cell Modem Service Agreement* in the Forms section of this manual. Then fax the completed form to (630) 348-2099.
- To install Wi-Fi, purchase a supported Wi-Fi adapter to connect via wireless network.

Unit Registration

Following installation, after reboot, you will be prompted to register the game. Use the gun to navigate through this process.

1. If you skip registration, you can do it later via the diagnostic menu by selecting the Online Menu, then selecting Game Registration Menu, then Game Register.
2. Login manually by entering your operator ID number and PIN.
3. Once logged in, follow the on-screen prompt to add or select a location and complete registration.
4. See Game Registration section for more detailed steps to complete this process.

Access CoinUp® Operator Center

The CoinUp® Operator Center tracks the performance of your games. For example, you can compare performance of different machines at the same location, or even across locations. To access CoinUp® and view your pages, follow the steps below. From there, the site provides guidance. You follow easy prompts and navigate to the statistic, accounting, bookkeeping or performance data that you need.

1. Access the CoinUp® Web site at www.coinup.com.
The CoinUp® Operator Center is the top page.
2. In the top right corner of the page, enter the account e-mail address.

Terminator Salvation™ 32" Dedicated Game

3. Enter the password.
4. (Optional) To change login information, use the Profile tab.
5. Select locations or products to view.

FCC Compliance You are solely responsible for FCC compliance on installations.

Network Installation

Installation Process Overview

1. Install the Internet Connection
2. Install software from game restore DVD, if needed.
3. Register the game.

DAMAGE POSSIBLE Be extra careful when drilling into the cabinet. Be sure not to drill into cabinet components. Drill only into empty space.

Install Ethernet Cable (option 1)

1. Set up DSL or cable modem service through an ISP.
2. Turn off AC power.
3. Unplug the power cord.
4. Center punch a hole for the Ethernet cable.
5. Using a 5/8-inch drill bit, drill a cable hole.
6. Run the Ethernet cable to the cabinet.
7. Route the Ethernet cable through the cabinet hole.
8. Open the back door.
9. Inside the cabinet, dress the Ethernet cable away from other cables and metallic parts.
10. Locate the RJ45 Ethernet jack on the back of the PC.
11. Connect the Ethernet cable to the RJ45 jack on the PC.
12. Close the back door.
13. Plug in power cord.
14. Turn on AC power.

Install Cell Modem (option 2)

1. Set aside the modem, Velcro® strips and extender cable.
2. Turn off AC power.
3. Unplug power cord.
4. Open the back door.
5. Remove the adhesive protection from one side of the Velcro® strips.
Keep the Velcro® strips together.
6. Locate a clear and accessible space for the modem near the PC.
7. Lift the modem and stick one side of the strips to the shelf beneath the modem location.
8. Remove the adhesive protection from the free side of the Velcro® strips.

9. Press the modem to the sticky side of the Velcro® strips.
Ensure that the modem bonds solidly.
10. In the kit, find the modem extender cable.
11. Connect the modem cable to a USB port on the PC.
12. Connect the other end of the modem cable to the cell modem.
13. (Optional) Install Cell Modem Antenna (see below)
14. Close the back door.
15. Plug in power cord.
16. Turn on AC power.

Install Cell Modem Antenna

A cell modem antenna is optional. However, an antenna will help ensure the best possible connection. Note that the cable is part of the antenna and these instructions cover mounting the antenna to the cabinet roof. However, other locations may provide better reception, such as a wall, near a window, etc.

Antenna Location Guidelines

- Keep the antenna vertical.
- Mount the antenna as high as possible.
- Avoid mounting an antenna near power lines.
- Avoid areas where people could trip on a cable.
- Don't tempt vandals: If possible, keep the antenna out of plain sight.

DAMAGE POSSIBLE Be extra careful when drilling into the cabinet. Be sure not to drill into cabinet components. Drill only into empty space.

DO NOT USE ADHESIVE Only use Velcro® strips for mounting antenna. Do not use the factory-applied, permanent adhesive backing. Doing so may damage the antenna and the cabinet when removing the antenna during a cabinet relocation. The warranty does not cover this sort of damage.

Antenna Installation

1. Set aside the antenna and the Velcro® strips from the kit.
2. Turn off AC power.
3. Unplug power cord.
4. Open the back door.
5. In a clear space, center punch the antenna cable hole.
6. Using a 5/8-inch hole bit, drill the hole for the antenna cable.
Avoid implosion. Read the warning above.
7. Slide the antenna coaxial cable down the cable hole and into the cabinet.
8. Remove the protective strip from one side of the Velcro® strips.
Keep the hook and loop Velcro® strips together.
9. Mount the sticky side of the Velcro® strips to the bottom of the antenna.
You can apply the Velcro® sticky side to the adhesive on the antenna base. Do not let the

Terminator Salvation™ 32" Dedicated Game

antenna adhesive come into contact with the cabinet. The Velcro® must separate the antenna adhesive and the cabinet.

10. Remove the adhesive protection from the free side of the Velcro® strip.
11. Mount the free side of the Velcro® strip to the roof.
12. Dress the antenna coaxial cable away from other cables and metallic parts.
13. Connect the antenna cable plug to the jack on the modem.
14. Close the back door.
15. Plug in power cord.
16. Turn on AC power.

Install Wi-Fi Adapter (option 3)

First, obtain one of the supported USB Wi-Fi adapters listed below.

WARNING Do **not** install the software that comes with the adapter. Terminator Salvation™ already runs appropriate Wi-Fi software.

ADAPTER MODEL	Supported Networks	Encryption Type / Compatible?							
		Disabled None	WEP	WPA-Personal + TKIP encryption	WPA-Personal + AES encryption	WPA2-Personal (AES encryption)	WPA2-Mixed (TKIP & AES)	WPA Enterprise	RADIUS
Linksys WUSB54G (version 4)	802.11b/g	YES	YES	YES	YES	NO	NO	NO	NO
Rosewill RNX-G1 RNX-G1W	802.11b/g	YES	YES	YES	YES	YES	YES	NO	NO
Netgear WG111 (version 2)	802.11b/g	YES	YES	YES	YES	YES	YES	NO	NO
D-Link DWA-140 (version 81)	802.11b/g	YES	YES	YES	YES	YES	YES	NO	NO
Belkin F5D8053 (version 3000)	802.11b/g/n	YES	YES	YES	YES	YES	YES	NO	NO
Linksys WUSB600N (version 1.0)	802.11b/g/n	YES	YES	YES	YES	YES	YES	NO	NO

Supported Wi-Fi Adapter Compatibility Chart

Once you have obtained a Wi-Fi adapter, follow this procedure to install it.

Wi-Fi Installation

1. Turn off cabinet AC power.
2. Unplug power cord.
3. Open the back door.
4. Mount Wi-Fi adapter inside cabinet as high as possible using Velcro®.
5. If necessary, use a USB extension cable to connect adapter to PC.
Most supported adapters come with a USB extension cable.
6. Connect cable to a USB port on the PC.
7. Close back door.
8. Plug in power cord.
9. Turn on AC power.

10. Complete Wi-Fi software setup.

Terminator Salvation™ will not connect properly to CoinUp® until setup is successfully completed.

Wi-Fi Software setup

WARNING Do **not** install the software that comes with the Wi-Fi adapter. Terminator Salvation™ already runs appropriate Wi-Fi software.

Prepare for Setup

1. Log into wireless access point or router.
2. Write down Wi-Fi network information on a sheet of paper:
 - SSID (network name)
 - Broadcast Channel
 - Encryption Type (WEP 64-bit, WEP 128-bit, WEP 256-bit, WPA-PSK + TKIP encryption, WPA-PSK + AES encryption, WPA2)
 - Encryption Key (Different encryption types require different types of keys. See chart below for examples)

Encryption Type	Key Details	Example
WEP (64-bit)	10 hexadecimal characters	5E2C6D4E24
WEP (128-bit)	26 hexadecimal characters	326C2D335A5A48386B5D763954
WEP (256-bit)	58 hexadecimal characters	373A786E625676266E7156345741 312F4433427C48536E7A695E7C3E75
WPA-PSK (AES) WPA-PSK (TKIP) WPA2 (AES + TKIP)	ASCII pass phrase between 8-63 characters long. (upper case letters, lower case letters, numbers and symbols are allowed).	\$3CurE_pA\$sPhRa\$e

Encryption Key Examples

Network SSID

1. Enter Diagnostics mode.
2. Select Online Menu, then select Wi-Fi Menu and select Wi-Fi Setup.
3. Select Scan Networks to look for nearby Wi-Fi networks.
Depending on settings, networks may not broadcast their SSID.
These networks are displayed as *****HIDDEN*****
To use a hidden network, select it, then enter the SSID manually when prompted.
4. Scroll through the detailed list to locate your network.
5. If network does not appear in list, Exit to previous menu and select Enter Manually, then enter SSID, encryption type, key and broadcast channel.
6. Select Use this Network to continue.

Encryption Type

1. From the list of encryption types, scroll through and highlight the appropriate type.
2. Select Use This Encryption to Continue

Terminator Salvation™ 32" Dedicated Game

Encryption Key

If the encryption type is disabled/open, skip this section, because there is no key.

1. At the Enter WPA Key screen, enter access point or router WPA Key (from information gathered during preparation earlier)
2. Select yellow < and > symbols to switch between letters, numbers and symbols.
3. On the letters page, select UPPER or lower to change case of letters
4. Select OK to continue.

Broadcast Channel

This section applies only if the SSID was entered manually.

1. Scroll through the list to highlight the appropriate channel.
2. If you are unsure of the correct broadcast channel, select Auto
3. Select use This Channel to continue.

Confirm Settings

1. Note the SSID, Encryption Type, Encryption Key and Channel on the confirmation screen.
2. If the information is incorrect, select Start Over to return to the Wi-Fi menu.
3. If the information is correct, select Save Settings to store the information.
The game automatically reboots.

Wi-Fi Details Status Messages

After reboot, Terminator Salvation™ attempts to connect to the wireless network using saved information. To see real-time connection status, enter the Diagnostics system and select Online Menu. Then select Wi-Fi Menu and then Wi-Fi Details. Below are the possible status messages. See Troubleshooting for further instructions.

Connected

The game has located wireless access point or router and successfully obtained an IP Address. The game is online and ready to be registered with CoinUp®.

Not Connected

The game is neither connected to a Wi-Fi network nor attempting to connect. Either no Wi-Fi adapter is connected to the PC, or Wi-Fi Setup procedure was not completed.

1. If Adapter status is Not Found, ensure a supported Wi-Fi adapter with correct version is connected.
2. If Adapter status shows the name of the adapter, ensure SSID status is also correct.

Locating Access Point...

A Wi-Fi adapter is connected to the PC and network information was saved. The game is trying to find an access point broadcasting a network with the saved information.

If game remains in this status more than five minutes, either the network information entered was incorrect, or the game cannot communicate with the access point.

1. Reboot game and return to Wi-Fi Details again.
2. If another five minutes pass with the same status, return to Wi-Fi Setup and re-enter network information.
3. Check network signal strength by scanning for available networks in Wi-Fi Setup.
4. If signal is weak, unplug AC power and move cabinet closer to the access point.

Obtaining IP Address

Terminator Salvation™ has found wireless access point or router and is acquiring an IP Address.

1. If this status displays for more than 5 minutes, reboot game.
2. Recheck status after reboot.

Game Registration

After the reboot following CoinUp® installation, you will be prompted to register your location. You can also register by entering the Diagnostic menu, selecting Online Menu, then Game Registration Menu and Game Register.

1. Press the START button to login manually. Enter ID and pin when prompted.
2. The Select A Location screen appears
3. The game downloads your locations from the CoinUp® server database automatically.
4. Scroll through the list to highlight the appropriate location.
5. Select Use This Location to continue.
6. If the location is not on the list, select Add New Location to continue.
7. When adding a new location, select each letter and then click OK to confirm.
8. After location is chosen, a confirmation screen is displayed.
9. The game checks for updates and messages, then enters Attract mode.
10. Cell Modem and Wi-Fi users: Check signal strength indicator.

In Attract Mode, look for a five-segment bar graph. You should see the graph in the bottom-left corner of your screen. (The indicator appears on all Attract Mode screens.)

Ethernet games also display the graph. Broadband signal strength is constant. When connected, it displays five green bars. When disconnected, the graph shows no bars.

Checking the Connection

Cell Users

1. Enter Diagnostic mode by pressing the TEST service button.
2. Select Online Menu—Connection Details—Cell Modem Details.
3. Note the signal strength, which appears as a fraction with a 5 in the denominator.
A strong signal is 5/5; a weak signal is 1/5 or 2/5.

Terminator Salvation™ 32" Dedicated Game

4. If strength is below 3/5, reposition the cell antenna and recheck signal strength.

Wi-Fi Users

1. Enter Diagnostic mode by pressing the TEST service button.
2. Select Online Menu, then select Wi-Fi Menu and Wi-Fi Details
3. Note the signal strength. More green bars is better.
4. Note the link quality. A higher percent is better.
5. If either link quality or signal strength is low, try repositioning the adapter.

All Users

1. Enter Diagnostic mode by pressing the TEST service button.
2. Select Online Menu then select Test Connection.
3. Watch as the game confirms that:
 - It can obtain a valid IP address.
 - It can contact the CoinUp® server.
 - It can access the CoinUp® database.
 - It can access the CoinUp® file server.
4. The right side of the screen reports test results: SUCCESS or FAILURE.
The only acceptable result is four SUCCESS indications.
If any test results in FAILURE, see the Troubleshooting chapter or call your distributor.

Online Operation

1. Ensure game remains connected to the Wi-Fi, cellular, or Ethernet network.
2. The hard drive stores data about the game location. If the hard drive is removed from the PC, important data will be lost. Do not swap or replace drives without authorization from CoinUp® management.
3. Keep game location data accurate. Before moving a game, have the PC communicate with the server, then unregister the game. Re-register the game with updated information at the new location.

Collection Procedure

The CoinUp® server tracks various book-keeping statistics including collections. To see them, log on to the CoinUp® Operator Center page at www.coinup.com and go to the Reports section.

1. During a normal collection, enter the Diagnostics system and select Collections.
2. Review the entire report.
The system calculates Gross Collection from the last time the report screen was cleared. This figure and the actual collection should agree.
3. Select Send Collections Message.
4. After sending the collections, coin related audits are automatically reset.
This allows coin audits to accurately reflect earnings since the last collection. If you don't send collections, the next collection won't match the figures on the Collections screen and you will

not be able to view your collections on www.coinup.com.

If you wish to reset the other game audits, go to Reset Menu and select Reset Game Audits.

- Split collection with location as usual.

CoinUp® debits your account for its portion.

Terminator Salvation™ Fee Schedule

Pricing is subject to change without notice

For certain online features, CoinUp® collects a small portion of game revenue at a fixed rate that operators cannot adjust. This portion is included in the player cost for any online play. The location portion of most game features can be adjusted through www.coinup.com under the Game Machines section, or at the game, by entering the Diagnostic menu system and selecting Operator Adjustments then selecting Player Cost. Make adjustments to each game.

Service	Operator	CoinUp®	Total	Who Pays	Note
Basic Play					
Start Cost	\$1.00	\$0.00	\$1.00	Player, at game	Operator portion is adjustable
Continue Cost	\$1.00	\$0.00	\$1.00	Player, at game	Operator portion is adjustable
Advertisement Download					
Per unit, per ad	N/A	\$0.00	\$0.00	Operator	N/A
Monthly Cell Service					
Per unit (if applicable)	N/A	\$27.00	\$27.00	Operator	Taxes and fees from cell provider

Operator discount is based on monthly CoinUp® fees per unit.

Monthly Fee per Unit	Discount
\$0-\$250	5.00%
\$251-\$500	6.00%
\$500 and above	7.00%

Note that discounts are not applicable to the monthly cellular service charges.

Accounting Guidelines

After the close of each billing cycle, the monthly CoinUp® billing statement, itemizing the costs of online services, is viewable through the operator account at www.coinup.com.

The statement shows the approximate date of the automatic debit, allowing time to deposit appropriate funds. The automatic debit charges the bank account submitted on your debit account form.

CoinUp® honors company checks but must receive them three or more business days before the debit date. Late or delinquent deposits may exclude a game from access to online features and incur late fees.

Terminator Salvation™ 32" Dedicated Game

Forms

All forms required to setup a CoinUp® account are in this section. Photocopy the form, fill it out, then sign and fax (or mail) it to the numbers or addresses on the back cover of this manual.

Authorization Agreement for Automated Payment

Participating Operator Agreement

Operator Registration

Cell Modem Service Agreement

Authorization Agreement for Automated Payments

I (we) hereby authorize Play Mechanix™ to initiate debit entries to my (our) bank account below at the depository financial institution named below, hereinafter called DEPOSITORY and to debit the same such account. To correct errors, I (we) authorize Play Mechanix™ to initiate credit entries to my (our) account below at DEPOSITORY and to credit the same account. I (we) acknowledge that the origination of ACH transactions to my (our) account must comply with the provisions of U.S. law. I (we) attach an unsigned and void check for a checking account for my (our) account indicated below. For savings account, I (we) attach document on bank letterhead containing Bank Routing Number and my (our) Account Number or a bank deposit slip for my (our) savings account.

Company Name		<input type="checkbox"/> Checking Account	<input type="checkbox"/> Savings Account
Address		Bank Account Number	
City, State, Zip		ABA Bank routing number	
Company Contact		Bank Name	
Phone Number ()	Fax number ()	Bank Address	
Email Address		City, State, Zip	
Distributor		Bank Phone Number ()	

NOTICE. To assist in verifying data, attach an unsigned, void, blank check or deposit slip from your account.

This authorization is to remain in full force and effect until Play Mechanix™ has received written notification from me (us) of its termination in such time and in such manner as to afford Play Mechanix™ and DEPOSITORY a reasonable opportunity to act on it.

NOTE: All written debit authorizations **MUST** provide that the receiver may revoke the authorization only by notifying the originator in the manner specified in the authorization.

Authorized Signature	Title	Date
(Signature must accompany this form.)		

Mail or fax completed form to **Play Mechanix™**
 800 Roosevelt Road, Suite D-103, Glen Ellyn, IL 60137
 Phone (630) 942-1070
 Fax (630) 942-1073
 Fax (630) 348-2099
 For processing, allow 6 to 10 business days.

Terminator Salvation™ 32" Dedicated Game

Participating Operator Agreement

This Participating Operator Agreement (this "**Agreement**") is dated as of this ____ day of _____, 20____, by and between Play Mechanix, Inc., an Illinois corporation with offices at 800 Roosevelt Road, Suite D-103, Glen Ellyn, Illinois 60137 ("**Play Mechanix**"), and

(**"Operator"** or **"You"**)

In consideration of mutual promises and other valuable consideration, the parties agree as follows.

1. APPLICATION

1.1 This Agreement applies to your use of Play Mechanix' CoinUp® enabled products, software, services and web sites (referred to collectively as the "**Services**" in this document). The Agreement is valid for one year from the date above and shall automatically renew for one year on the anniversary date of this Agreement unless otherwise cancelled in writing.

1.2 Unless otherwise agreed in writing with Play Mechanix, your agreement with Play Mechanix will always include, at a minimum, the terms and conditions set out in this Agreement.

2. ACCEPTING THE TERMS

In order to use the Services, You must first agree to the terms and provisions of this Agreement (the "**Terms**"). You may not use the Services if You do not accept the Terms. You can accept the Terms by signing the bottom of this Agreement.

3. PROVISION OF THE SERVICES BY Play Mechanix™

3.1 Play Mechanix agrees to:

- Provide access to CoinUp® servers via Operator's video game(s) that contain CoinUp® enabled software.
- Provide Operator access to CoinUp® servers via www.coinup.com.
- Run CoinUp® sponsored tournaments from time to time throughout the year and include Operator's video games(s) in such tournaments to the extent that federal, state and local laws provide.
- Take responsibility for fulfillment and distribution of CoinUp® sponsored tournament prizes.
- Manage and support CoinUp® players' online Trophy Club™ and allow players access to their statistics via www.bigbuckhunter.com and www.coinup.com.
- Provide billing statements to Operator. Play Mechanix will make an electronic copy of the Operator's monthly bill available online at www.coinup.com at least four business days before automatically debiting fees due according to the Authorization Agreement (defined in [Paragraph 4.1](#) below). (These fees accrue to Play Mechanix.)
- Provide periodic statements for CoinUp® entry fees, and IRS 1099 reporting for CoinUp® sponsored prize awards.
- Warrant CoinUp® online kit parts for 90-day replacement against defects in materials and workmanship.
- Promote the CoinUp®, CoinUp® sponsored tournaments and gameplay on Play Mechanix products.

3.2 YOU ACKNOWLEDGE AND AGREE THAT PLAY MECHANIX WILL **NOT** PROVIDE PRIZES FOR TOURNAMENTS THAT ARE CUSTOM CREATED BY THE OPERATOR, THOSE PRIZE AWARDS WILL BE THE SOLE RESPONSIBILITY OF THE OPERATOR.

3.3 Play Mechanix is constantly innovating in order to provide the best possible experience for its users. You acknowledge and agree that the form and nature of the Services which Play Mechanix provides may change from time to time without prior notice to You.

3.4 As part of this continuing innovation, You acknowledge and agree that Play Mechanix may stop (permanently or temporarily) providing the Services (or any features within the Services) to You or to users generally at Play Mechanix' sole discretion, without prior notice to You.

4. USE OF SERVICES BY OPERATOR

4.1 Operator agrees to...

- Submit a completed Authorization Agreement for Automated Payments form (the “**Authorization Agreement**”).
- Properly register Operator’s video games that utilize the CoinUp® system and keep each game’s location information accurate.
- Keep Operator’s account profile information on the CoinUp® servers up to date and accurate via the www.coinup.com website.
- Ensure that CoinUp® sponsored tournament rules and regulations are followed on location and report non-compliance or cheating immediately to Play Mechanix.
- Report significant malfunctions of equipment and software to Play Mechanix.
- The schedule of CoinUp® fees that will be charged for usage of the CoinUp® system may change from time to time. The current CoinUp® Fee Schedule is available by request from www.coinup.com. Operator further agrees that the CoinUp® Fee Schedule that is contained in the documents section of www.coinup.com at the time of signing this Agreement is the version that shall apply.
- Ensure adequate funds are available in the account specified in the Authorization Agreement to pay monthly bills due Play Mechanix pursuant to the terms of the Authorization Agreement. A \$40.00 late fee will apply for insufficient funds available for transfer.
- To use the Services only for purposes that are permitted by (a) the Terms and (b) any applicable law, regulation or generally accepted practices or guidelines in the relevant jurisdictions.
- Be responsible for fulfillment of prizes to participants in contests custom created by Operator using the CoinUp® system and do so in a prompt and accurate manner.
- Allow Play Mechanix to place corporate sponsorships and advertisements on CoinUp® enabled video games.
- You agree not to access (or attempt to access) any of the Services by any means other than through the interface(s) provided by Play Mechanix.
- You agree that You will not engage in any activity that interferes with or disrupts the Services (or the servers and networks which are connected to the Services).
- You agree that You will not reproduce, duplicate, copy, sell, trade or resell the Services for any purpose.
- Operator agrees that any violation of the Terms shall be grounds for immediate termination by Play Mechanix of this Agreement.

5. TOURNAMENT PROCEEDS & TAXES & LEGALITY

The Operator agrees to pay taxes, fees, licenses and assessments (“**Fees**”) on CoinUp® monies that may become due as a result of using Services. Operator shall insure that the operation of the CoinUp® system is conforming with all local, and state laws; and shall not operate the CoinUp® system in any jurisdiction where it is illegal to do so.

6. PASSWORDS AND ACCOUNT SECURITY

6.1 You agree and understand that You are responsible for maintaining the confidentiality of passwords associated with any account You use to access the Services.

6.2 Accordingly, You agree that You are responsible to Play Mechanix for all activities that occur under your account.

6.3 If You become aware of any unauthorized use of your password or of your account, You agree to notify Play Mechanix immediately.

Terminator Salvation™ 32" Dedicated Game

7. CONTENT IN THE SERVICES

7.1 You understand that all information (such as data files, written text, music, audio files or other sounds, photographs, videos or other images) which You may have access to as part of, or through your use of, the Services (all such information is referred to below as the “**Content**”) is the sole responsibility of the person from which such Content originated.

7.2 You should be aware that Content presented to You as part of the Services, including but not limited to advertisements in the Services and sponsored Content within the Services may be protected by intellectual property rights which are owned by the sponsors or advertisers who provide that Content to Play Mechanix (or by other persons or companies on their behalf). You may not modify, rent, lease, loan, sell, distribute or create derivative works based on this Content (either in whole or in part) unless You have been specifically told that You may do so by Play Mechanix or by the owners of that Content, as the case may be, in a separate written agreement.

7.3 Play Mechanix reserves the right (but shall have no obligation) to pre-screen, review, flag, filter, modify, refuse or remove any or all Content from any Services.

7.4 You agree that You are solely responsible for (and that Play Mechanix has no responsibility to You or to any third party for) any Content that You submit, post, transmit or display on, or through, the Services (all such Content is referred to below as the “**Operator Content**”) and for the consequences of your actions (including any loss or damage which Play Mechanix may suffer) by doing so.

7.5 You agree that You will not willfully or knowingly upload Operator Content to the CoinUp® servers that violates the copyright or trademark of another individual or entity; provided, however, you agree to indemnify Play Mechanix for any losses it may sustain as a result of such upload that violates the copyright or trademark of another individual or entity, whether or not such violation was committed willfully or knowingly.

8. PROPRIETARY RIGHTS

8.1 During the course of this Agreement, You may become aware of information relating to the Play Mechanix’ products, software research and development, inventions, processes, techniques, designs or other technical or business information, including, but not limited to information relating to the Software and the Services and proprietary information developed by Play Mechanix in the course of developing and producing the Software and the Services. All such information and all physical forms thereof, including the Terms, whether disclosed to You before or after this Agreement is signed, are considered by Play Mechanix to be proprietary and confidential, and shall be hereinafter collectively referred to as the “**Proprietary Information**”.

8.2 Both during the term of this Agreement and after this Agreement is terminated, You agree that, except as authorized by this Agreement or in writing by Play Mechanix, You will: (i) preserve and protect the confidentiality of all Proprietary Information; (ii) not disclose or otherwise disseminate to anyone, except as necessary to carry out the Terms, the existence, source, content or substance of the Proprietary Information; (iii) not use Proprietary Information in any way other than in furtherance of this Agreement; and (iv) not disclose, use or copy any information or materials received in confidence by You during the course of this Agreement from a third party or about a third party.

8.3 You acknowledge and agree that Play Mechanix (or Play Mechanix’ licensors) own all legal right, title and interest in and to the Services, including any intellectual property rights which subsist in the Services (whether those rights happen to be registered or not, and wherever in the world those rights may exist). You further acknowledge that the Services contain information which is designated confidential by Play Mechanix and that You shall not disclose such information without Play Mechanix’ prior written consent.

8.4 Unless You have agreed otherwise in writing with Play Mechanix, nothing in the Terms gives You a right to use any of Play Mechanix’ trade names, trademarks, service marks, logos, domain names and other distinctive brand features.

8.5 Other than the Operator Content License described in [Section 10](#) below, Play Mechanix acknowledges and agrees that it obtains no right, title or interest from You (or your licensors) under these Terms in or to the Operator Content, including any intellectual property rights which subsist in the Operator Content (whether those rights happen to be registered or not, and wherever in the world those rights may exist). Unless You have agreed otherwise in writing with Play Mechanix, You agree that You are responsible for protecting and enforcing such rights and that Play Mechanix has no obligation to do so on your behalf. Play Mechanix further acknowledges that servers may contain information which is designated confidential by You

and that Play Mechanix shall not disclose such information without your prior written consent.

8.6 You agree that You shall not remove, obscure or alter any proprietary rights notices (including copyright and trade mark notices) which may be affixed to or contained within the Services.

8.7 Unless You have been expressly authorized to do so in writing by Play Mechanix, You agree that in using the Services, You will not use any trade mark, service mark, trade name or logo of any company or organization in a way that is likely or intended to cause confusion about the owner or authorized user of such marks, names or logos.

9. LICENSE FROM Play Mechanix™

9.1 Play Mechanix gives You a worldwide, royalty-free, non-assignable and non-exclusive license (the “**Software License**”) to use the software provided to You by Play Mechanix as part of the Services as provided to You by Play Mechanix (hereinafter referred to as the “**Software**”). The Software License is for the sole purpose of enabling You to use and enjoy the benefit of the Services as provided by Play Mechanix, in the manner permitted by the Terms.

9.2 You may not (and You may not permit anyone else to) copy, modify, create a derivative work of, reverse engineer, decompile or otherwise attempt to extract the source code of the Software or any part thereof, unless it is expressly required by law, or unless You have been specifically told that You may do so by Play Mechanix in writing.

9.3 Unless Play Mechanix has given You specific written permission to do so, You may not assign (or grant a sub-license of) your rights to the Software License, grant a security interest in or over your rights to the Software License, or otherwise transfer any part of your rights to the Software License.

10. CONTENT LICENSE FROM YOU

10.1 You retain copyright and any other rights You already hold in the Operator Content. By submitting, posting or displaying the Operator Content, You give Play Mechanix a perpetual, irrevocable, worldwide, royalty-free, paid-up and non-exclusive license (the “**Operator Content License**”) to reproduce, adapt, modify, translate, publish, publicly perform, publicly display and distribute the Operator Content. The Operator Content License is for the sole purpose of enabling Play Mechanix to display, distribute and promote the Services.

10.2 You agree that the Operator Content License includes a right for Play Mechanix to make the Operator Content available to other companies, organizations or individuals with whom Play Mechanix has relationships for the provision of syndicated services, and to use the Operator Content in connection with the provision of those services.

10.3 You understand that Play Mechanix, in performing the required technical steps to provide the Services to our users, may (a) transmit or distribute the Operator Content over various public networks and in various media; and (b) make such changes to the Operator Content as are necessary to conform and adapt the Operator Content to the technical requirements of connecting networks, devices, services or media. You agree that the Operator Content License shall permit Play Mechanix to take these actions.

10.4 You confirm and warrant to Play Mechanix that You have all the rights, power and authority necessary to grant the Operator Content License described in this [Section 10](#).

11. SOFTWARE UPDATES

11.1 The Software which You use may automatically download and install updates from time to time from Play Mechanix. These updates are designed to improve, enhance and further develop the Services and may take the form of bug fixes, enhanced functions, new software modules and completely new versions. You agree to receive such updates (and permit Play Mechanix to deliver these to You) as part of your use of the Services.

Terminator Salvation™ 32" Dedicated Game

12. EXCLUSION OF WARRANTIES

12.1 NOTHING IN THESE TERMS, INCLUDING SECTIONS 12 AND 13, SHALL EXCLUDE OR LIMIT PLAY MECHANIX' WARRANTY OR LIABILITY FOR LOSSES WHICH MAY NOT BE LAWFULLY EXCLUDED OR LIMITED BY APPLICABLE LAW. SOME JURISDICTIONS DO NOT ALLOW THE EXCLUSION OF CERTAIN WARRANTIES OR CONDITIONS OR THE LIMITATION OR EXCLUSION OF LIABILITY FOR LOSS OR DAMAGE CAUSED BY NEGLIGENCE, BREACH OF CONTRACT OR BREACH OF IMPLIED TERMS, OR INCIDENTAL OR CONSEQUENTIAL DAMAGES. ACCORDINGLY, ONLY THE LIMITATIONS WHICH ARE LAWFUL IN YOUR JURISDICTION WILL APPLY TO YOU AND OUR LIABILITY WILL BE LIMITED TO THE MAXIMUM EXTENT PERMITTED BY LAW.

12.2 YOU EXPRESSLY UNDERSTAND AND AGREE THAT YOUR USE OF THE SERVICES IS AT YOUR SOLE RISK AND THAT THE SERVICES ARE PROVIDED "AS IS" AND "AS AVAILABLE."

12.3 IN PARTICULAR, PLAY MECHANIX, ITS PARENT, ITS SUBSIDIARIES AND AFFILIATES, AND ITS LICENSORS DO NOT REPRESENT OR WARRANT TO YOU THAT:

- (A) YOUR USE OF THE SERVICES WILL MEET YOUR REQUIREMENTS;
- (B) YOUR USE OF THE SERVICES WILL BE UNINTERRUPTED, TIMELY, SECURE OR FREE FROM ERROR;
- (C) ANY INFORMATION OBTAINED BY YOU AS A RESULT OF YOUR USE OF THE SERVICES WILL BE ACCURATE OR RELIABLE; AND
- (D) THAT DEFECTS IN THE OPERATION OR FUNCTIONALITY OF ANY SOFTWARE PROVIDED TO YOU AS PART OF THE SERVICES WILL BE CORRECTED.

12.4 YOU EXPRESSLY UNDERSTAND AND AGREE THAT ANY MATERIAL DOWNLOADED OR OTHERWISE OBTAINED THROUGH THE USE OF THE SERVICES IS DONE AT YOUR OWN DISCRETION AND RISK AND THAT YOU WILL BE SOLELY RESPONSIBLE FOR ANY DAMAGE TO YOUR COMPUTER SYSTEM OR OTHER DEVICE OR LOSS OF DATA THAT RESULTS FROM THE DOWNLOAD OF ANY SUCH MATERIAL.

12.5 YOU EXPRESSLY UNDERSTAND AND AGREE NO ADVICE OR INFORMATION, WHETHER ORAL OR WRITTEN, OBTAINED BY YOU FROM PLAY MECHANIX OR THROUGH OR FROM THE SERVICES SHALL CREATE ANY WARRANTY NOT EXPRESSLY STATED IN THE TERMS.

12.6 PLAY MECHANIX FURTHER EXPRESSLY DISCLAIMS ALL WARRANTIES AND CONDITIONS OF ANY KIND, WHETHER EXPRESS OR IMPLIED, INCLUDING, BUT NOT LIMITED TO THE IMPLIED WARRANTIES AND CONDITIONS OF MERCHANTABILITY, FITNESS FOR A PARTICULAR PURPOSE AND NON-INFRINGEMENT.

13. LIMITATION OF LIABILITY

13.1 SUBJECT TO THE PROVISIONS OF PARAGRAPH 12.1 ABOVE, YOU EXPRESSLY UNDERSTAND AND AGREE THAT PLAY MECHANIX, ITS PARENT, ITS SUBSIDIARIES AND AFFILIATES, AND ITS LICENSORS SHALL NOT BE LIABLE TO YOU FOR:

- (A) ANY DIRECT, INDIRECT, INCIDENTAL, SPECIAL CONSEQUENTIAL OR EXEMPLARY DAMAGES WHICH MAY BE INCURRED BY YOU, HOWEVER CAUSED AND UNDER ANY THEORY OF LIABILITY. THIS SHALL INCLUDE, BUT NOT BE LIMITED TO, ANY LOSS OF PROFIT (WHETHER INCURRED DIRECTLY OR INDIRECTLY), ANY LOSS OF GOODWILL OR BUSINESS REPUTATION, ANY LOSS OF DATA SUFFERED, COST OF PROCUREMENT OF SUBSTITUTE GOODS OR SERVICES, OR OTHER INTANGIBLE LOSS; OR
- (B) ANY LOSS OR DAMAGE WHICH MAY BE INCURRED BY YOU, INCLUDING BUT NOT LIMITED TO LOSS OR DAMAGE AS A RESULT OF:
 - (I) ANY RELIANCE PLACED BY YOU ON THE COMPLETENESS, ACCURACY OR EXISTENCE OF ANY ADVERTISING, OR AS A RESULT OF ANY RELATIONSHIP OR TRANSACTION BETWEEN YOU AND ANY ADVERTISER OR SPONSOR WHOSE ADVERTISING APPEARS ON THE SERVICES; OR
 - (II) ANY CHANGES WHICH PLAY MECHANIX MAY MAKE TO THE SERVICES, OR FOR ANY PERMANENT OR TEMPORARY CESSATION IN THE PROVISION OF THE SERVICES (OR ANY FEATURES WITHIN THE SERVICES); OR
 - (III) THE DELETION OF, CORRUPTION OF, OR FAILURE TO STORE, ANY CONTENT AND OTHER COMMUNICATIONS DATA MAINTAINED OR TRANSMITTED BY OR THROUGH YOUR USE OF THE SERVICES; OR
 - (III) YOUR FAILURE TO PROVIDE PLAY MECHANIX WITH ACCURATE ACCOUNT INFORMATION; OR
 - (IV) YOUR FAILURE TO KEEP YOUR PASSWORD OR ACCOUNT DETAILS SECURE AND CONFIDENTIAL.

13.2 THE LIMITATIONS ON PLAY MECHANIX' LIABILITY TO YOU IN PARAGRAPH 13.1 ABOVE SHALL APPLY WHETHER OR NOT PLAY MECHANIX HAS BEEN ADVISED OF OR SHOULD HAVE BEEN AWARE OF THE POSSIBILITY OF ANY SUCH LOSSES ARISING.

14. COPYRIGHT AND TRADEMARK POLICY

14.1 It is Play Mechanix' policy to respond to notices of alleged copyright infringement that comply with applicable international intellectual property law (including, in the United States, the Digital Millennium Copyright Act) and to terminate the accounts of infringers.

15. MISCELLANEOUS

15.1 This Agreement shall be governed and interpreted in accordance with the substantive laws of the State of Illinois. The parties agree that any litigation for injunctive relief shall be resolved in the state or federal courts within Cook County, Illinois.

15.2 Should any provision of this Agreement be held void, invalid or inoperative, by a Court of competent jurisdiction, the remaining provisions of this Agreement shall not be affected and shall continue in full force and effect.

15.3 This Agreement states the entire agreement between parties with respect to the subject hereof and supersedes all prior oral and written negotiations, understandings and agreements between the parties hereto concerning the subject matter hereof. No amendment or modification of this Agreement shall be made except by an instrument in writing signed by both parties.

15.4 No waiver of any of the provisions of this Agreement or any breach thereof or failure of any condition therein shall be deemed, or shall constitute, a waiver of any other provision, whether or not similar, nor shall any waiver constitute a continuing waiver. No waiver shall be implied from any conduct or course of conduct of any party. No waiver shall be binding unless executed in writing by the party making the waiver.

15.5 Subject to the restrictions on transfer herein, this Agreement shall inure to the benefit of and be binding upon Play Mechanix and Operator and their respective heirs, executors, trustees, beneficiaries, legal representatives, successors and assigns.

15.6 Except for Play Mechanix' parent corporation, no other person, corporation, partnership or other entity, shareholder, director, officer, employee, independent contractor, vendor, customer or any other third party shall be deemed to be a third party beneficiary of any provisions herein.

By

OPERATOR LEGAL COMPANY NAME

OPERATOR SIGNATURE

Play Mechanix™ Inc., an Illinois corporation

Play Mechanix™ Authorized Signature

Terminator Salvation™ 32" Dedicated Game



Operator Registration Form		
<ul style="list-style-type: none">• Before you register games, you must register an operator account!		
Operator Name		
Company Name		
Operator Address		
City, State, Zip		
Country		
Operator Phone		
Operator Fax		
Operator Email		
Contact Preference	<input type="checkbox"/> Email	<input type="checkbox"/> Phone
Debit Account On File:	<input type="checkbox"/> Yes	<input type="checkbox"/> No (If No, include Authorization Agreement for Automated Payments.)
<i>Mail or fax completed form to Play Mechanix™</i> 800 Roosevelt Road, Suite D-103, Glen Ellyn, IL 60137 Phone (630) 942-1070 Fax (630) 942-1073 Fax (630) 348-2099 <i>For processing, allow 2 to 5 business days.</i>		

- After Play Mechanix™ receives your registration, login information for your accounts will be mailed.
- To register games online, manually log in with your operator number and PIN.
- To log in to your CoinUp® Account at www.coinup.com, use your email address and password.
- After you receive your login information, you can change it through your Web account. To change your account information, use the My Profile tab.

Cell#	IMEI	L.O.S	Operator ID#
-------	------	-------	--------------

Rev. C1

CoinUp® Cellular Terms of Service Agreement

This agreement is made between Play Mechanix™, Inc. (“PM”, “we”, “us”, or “ours”) and the Operator (“Operator”, “you”, or “your”) and covers the usage and fees associated with a cellular modem device (“Equipment”) that you order from us connected to one of your games allowing it to communicate with the CoinUp® online network (“Service”). This agreement must be signed and returned to us before we will activate a new line of service. PLEASE READ THIS AGREEMENT CAREFULLY BEFORE ORDERING CELLULAR SERVICE FOR YOUR CoinUp® CONNECTED GAME AND SIGNING THIS AGREEMENT.

Provision of Services

Upon ordering the cellular modem, Play Mechanix™, Inc. will in turn order a line of cellular service (“Service”) for the cellular modem. Play Mechanix™, Inc. provides cellular service from one or more cellular providers of service throughout the United States (“Cellular Provider”). We do this to gain volume pricing for you and thereby lower the price of the Service. All costs charged to Play Mechanix™, Inc. for your line of cellular service are passed through directly to you. Ordering the Service from us is not the only option for you. You may obtain cellular service independently to connect your game. In this case, you will be responsible for all service fees and commitments. Please contact Play Mechanix™, Inc. before ordering your own cellular modem to ensure that you purchase a modem device that will be compatible with the game.

Service Commitment and Early Termination Fee

By ordering this Service the Operator agrees to the following:

To pay the monthly fee associated with each line of service which will be billed to your CoinUp® account. To keep the Service for at least a period of one year from the date of ordering (“Service Commitment”). After the initial one year term you may terminate the service at anytime with 30 days notice. If you wish to terminate the Service prior to the initial one year term, you agree to pay us an Early Termination Fee of \$175. The Early Termination Fee is not a penalty but rather the exact fee we will be charged by the cellular provider. AFTER YOUR SERVICE COMMITMENT THIS AGREEMENT SHALL RENEW ON A MONTH-TO-MONTH BASIS UNTIL EITHER PARTY GIVES NOTICE OF TERMINATION TO THE OTHER.

30-Day Cancellation Period

You may terminate this agreement within thirty (30) days after activating without paying The Early Termination Fee. You will pay for service fees and charges incurred through the termination date. Also you may have to return the cellular modem purchased with this agreement. If you terminate after the 30th day but before the expiration of the Service Commitment, you will pay PM the Early Termination Fee associated with the line of service terminated. Either party may termination this agreement at any time after your Service Commitment ends with thirty (30) days notice to the other party. We may terminate this agreement at any time without notice if Cellular Provider ceases to provide service in your area. We may interrupt or terminate your service without notice for any conduct that we believe violates this agreement, or if you fail to make available funds to pay for service when due, or if we have reasonable cause to believe that your Equipment is being used for an unlawful purpose or in a way that may adversely affect the Cellular Provider’s service.

Charges and Disputes

You are responsible for paying all charges for or resulting from services provided under this agreement. Your monthly service charges will be billed through your CoinUp® account. Play Mechanix™, Inc. passes through charges directly from the Cellular Provider. If you believe that there is an error in the amount charged to your account for cellular service you may contact Play Mechanix™, Inc. to provide proof of charges from the Cellular

Terminator Salvation™ 32" Dedicated Game

Provider for your service. You agree that Play Mechanix™, Inc. will handle all negotiation of rate fees and billing with the Cellular Provider. Play Mechanix™, Inc. agrees to use its best efforts to resolve any and all billing disputes with the Cellular Provider. Play Mechanix™, Inc. will in its sole discretion determine if a billing error has occurred.

Billing and Payment

Billing takes place through your CoinUp® operator account. All methods of payment and late fees described in your CoinUp® Operator Agreement shall apply.

Changes to Terms and Rates

The Cellular Provider may from time to time change the rates charged for the Service. Generally, if the Cellular Provider raises the rate for Service they will allow us to discontinue the Service without fee or penalty. If Play Mechanix™, Inc. receives notice of a rate increase from the Cellular Provider associated with your Service we agree to notify you and allow you the same option given to us. If the Cellular Provider lower the rate for Service, the new rate will automatically take effect for you on the same date that it takes effect for us.

Data Connection Limitations

Play Mechanix™, Inc. limits the capabilities of the Equipment so that it is only allowed to make data connections to CoinUp® servers. You agree not to use the Cellular Service provided by us for any other purpose than connecting your Game to the CoinUp® network. If Play Mechanix™, Inc. finds that you are using the Cellular Service for any other such purpose including but not limited to, web browsing, voice calls, and text messaging then we may immediately terminate the Cellular Service in which case you will pay all fees charged to this line of Service including the Early Termination Fee if we terminate this Service before the expiration of the Service Commitment.

Service Limitations and Limitation of Liability

Service may be interrupted, delayed, or otherwise limited for a variety of reasons, including environmental conditions, unavailability of radio frequency channels, system capacity, priority access by National Security and Emergency Preparedness personnel in the event of disaster or emergency, coordination with other systems, equipment modifications and repairs, and problems with the facilities of interconnecting carriers. WE DO NOT GUARANTEE YOU UNINTERRUPTED SERVICE OR COVERAGE. Play Mechanix™, INC. MAKES NO WARRANTY, EXPRESS OR IMPLIED, OF MERCHANTABILITY OR FITNESS FOR A PARTICULAR PURPOSE, SUITABILITY, OR PERFORMANCE REGARDING ANY SERVICES OR GOODS, AND IN NO EVENT SHALL PM BE LIABLE, WHETHER OR NOT DUE TO ITS OWN NEGLIGENCE, for any: (a) act or omission of a third party; (b) mistakes, omissions, interruptions, errors, failures to transmit, delays, or defects in the service provided by or through us; or (c) damage or injury caused by suspension or termination of service by PM. To the full extent allowed by law, you hereby release, indemnify and hold PM and its officers, directors, employees and agents harmless from and against any and all claims of any person or entity for damages of any nature arising in any way from or relating to, directly or indirectly, service provided by PM or any person's use thereof, INCLUDING CLAIMS ARISING IN WHOLE OR IN PART FROM THE ALLEGED NEGLIGENCE OF PM, or any violation by you of this Agreement. This obligation shall survive termination of your service with PM. PM is not liable to you for changes in operation, equipment, or technology that cause your Equipment or software to be rendered obsolete or require modification. SOME STATES DO NOT ALLOW DISCLAIMERS OF IMPLIED WARRANTIES OR LIMITS ON REMEDIES FOR BREACH. THEREFORE, THE ABOVE LIMITATIONS OR EXCLUSIONS MAY NOT APPLY TO YOU. THIS AGREEMENT GIVES YOU SPECIFIC LEGAL RIGHTS, AND YOU MAY HAVE OTHER RIGHTS WHICH VARY FROM STATE TO STATE.

Miscellaneous

This agreement, the signature sheet, terms of service for products and services not otherwise described herein that are posted on applicable PM web sites, and any documents expressly referred to herein or therein, make up the complete agreement between you and PM. If any provision of the agreement is found to be unenforceable by a court or agency of competent jurisdiction, the remaining provisions will remain in full force and effect. PM may assign this agreement, but you may not assign this agreement without our prior written consent. The law of the state of your billing address shall govern this agreement except to the extent that such law is preempted by or inconsistent with applicable federal law.

Signatures

Play Mechanix™, Inc.

Operator Legal Name:

By:

By:

Name/Title:

Name/Title:

Date:

Date:

Terminator Salvation™ 32" Dedicated Game

Contact Information

For an authorized distributor near you, check the Raw Thrills website at www.rawthrills.com

Contact Betson Enterprise Headquarters or your local Betson office for sales, technical information, warranty or repair. Betson can be reached at (800) 524-2343 Fax (201) 438-4837 www.betson.com

CoinUp® Service

PlayMechanix™ www.playmechanix.com
800 Roosevelt Road, Suite D-103
Glen Ellyn, IL 60137
(630) 942-1070 fax (630) 942-1073

Raw Thrills, Inc.

5441 Fargo Ave.
Skokie, IL 60077
(800) 753-2513 fax (201) 438-5019

Betson Southeast

2150 Newmarket Pkwy. Suite 100
Marietta, GA 30067
(877) 758-9601 or (770) 303-0146

Betson Enterprises Headquarters

303 Paterson Plank Rd.
Carlstadt, NJ 07072
(800) 524-2343 or (201) 438-1300
fax (201) 438-4837

Betson Philadelphia Distributing

310 Hansen Access Rd.
King of Prussia, PA 19406
(610) 265-1155 fax (610) 265-0909

Betson New England

560 Turnpike St.
Canton, MA 02021
(781) 821-8533 or (800) 274-6326
fax (781) 821-9082

Betson West-Buena Park

5660 Knott Ave.
Buena Park, CA 90621
(714) 228-7500 fax (714) 228-7515

Betson Advance Distributing

6743 Thompson Rd.
Syracuse, NY 13211
(315) 437-2400 Fax (315) 437-6130

Betson Midwest

1158 Tower Lane
Bensenville, IL 60106
(630) 238-9400 Fax (630) 238-9409

Betson Pittsburgh Distributing

2707 West Carson St.
Pittsburgh, PA 15204
(412) 331-8703 fax (412) 331-0712

Betson West

3470 Depot Road
Hayward, CA 94545
(510) 293-9127 or (800) 526-7906
fax(510) 785-5317

Betson Baltimore Distributing

6615 Tributary St. Suite F
Baltimore, MD 21224
(410) 646-4100 or (800) 296-4100

Suzo-Happ Group (for gun parts only)

106 Garlisch Drive
Elk Grove, IL 60007
(888) 289-4277

Betson Texas Distributing

1127 Conveyor Lane
Dallas, TX 75247
(214) 638-4900 or (877) 638-4900
Fax (214) 638-4925